

The Reliable Solution for Automated Conveying Systems: Inverted-Tooth Chains from Rexroth

Rexroth inverted tooth conveyor chains for automation



The flexible solution for your conveying applications: Inverted tooth chains from Rexroth

Our inverted tooth chains transport and convey products, workpieces, and materials securely and reliably, whether processed or unprocessed, large or small, light or heavy, bulky or round. Rexroth inverted tooth conveyor chains guarantee success in every area.



The technical variety of inverted tooth conveyor chains covers a wide range of applications. Whether for heavy-duty, robust operation, or to convey parts with small or large dimensions, processed or unprocessed workpieces, or even fragile items: An inverted tooth chain is the profitable solution for all types of use.

Rexroth inverted tooth conveyor chains

The **variable construction** of an inverted tooth chain guarantees the optimal execution of the respective conveying task. Thanks to the multitude of available link plate forms, in many cases it's possible to **fix** the goods to be conveyed right onto the inverted tooth chain—**without additional mechanisms**. If required, **uncomplicated** and additional link plates for workpiece transport may be attached to the conveyor.

Depending on their type and shape, products are transported directly on the inverted tooth chain that are designed according to the specific requirements. For special needs, inverted tooth chains are also available with smoothed surfaces. With the help of product carriers or pallets, bulky items are brought to the required position by two narrow inverted tooth chains. The inverted tooth chain features **smooth and even running**, a special advantage in case of difficult geometry, e.g. a high center of gravity.

Various pitches, link plate forms, and materials are available in order to make the right chain selection in terms of weight and ambient conditions. The advantages of inverted tooth chains become even clearer when moving heavy goods—these chains are also available with shortened and leveled link teeth which **reduce surface pressure**.

Larger surface areas also offer a **better sliding quality**. Rexroth's characteristic 2-part rolling pivot joint minimizes the unavoidable elongation in steel link chains. By **significantly lengthening your replacement intervals**, Rexroth can also **reduce your costs** when it comes to the purchase of spare parts.

Substantially extended equipment life and significantly reduced downtime—Rexroth inverted tooth conveyor chains assure cost-effective production.

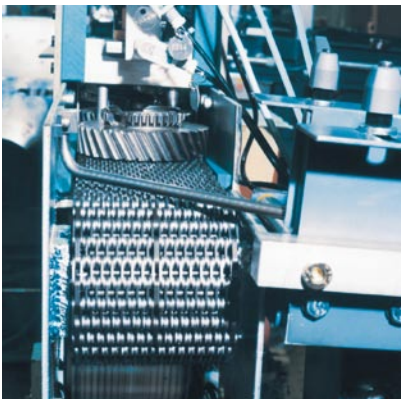
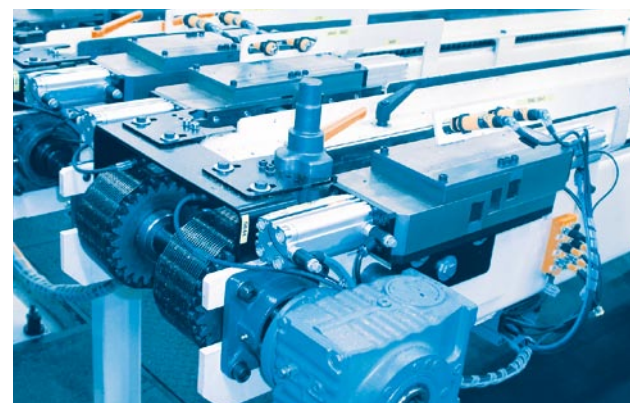
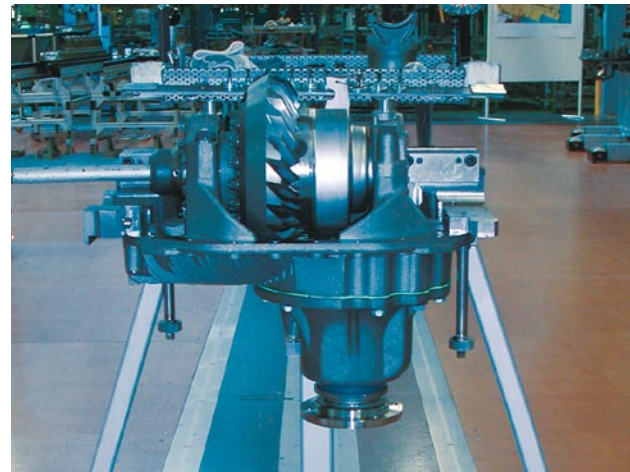

A distinguished conveying system

Inverted tooth chains for conveying and linkage systems provide optimum conveyor-belt systems. Rexroth has extensive experience in this area. Economical, user-friendly solutions are the main priority for our conveying technology, which is unsurpassed in terms of service life and availability.

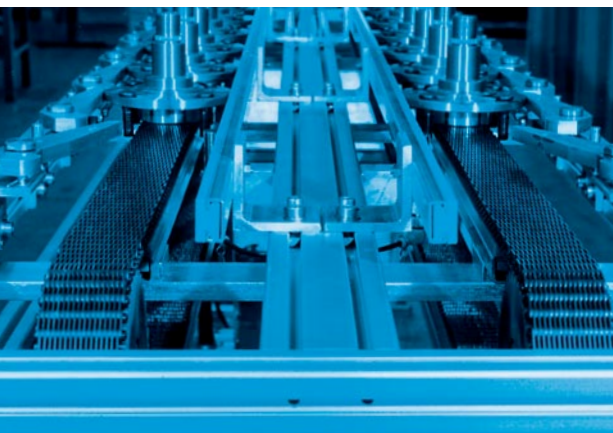
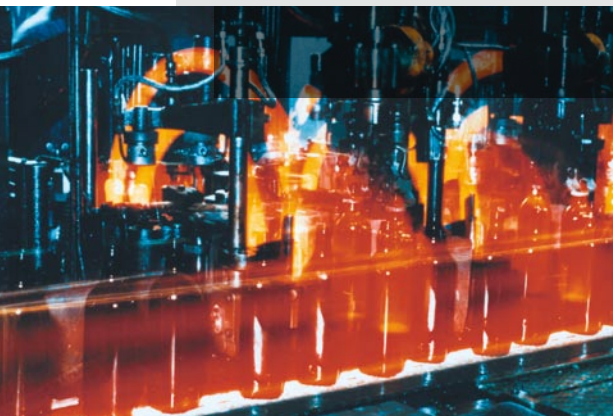

Inverted tooth conveyor chains from Rexroth work slip-free and bring every part to the right location at the prescribed time.

Depending on their type and shape, the workpieces sit either directly on the chains, on pallets, or on carrier devices that have been specially integrated into the chain. More than 500 different driver link plates are also available to help accomplish this task.

Inverted tooth chains from Rexroth:

- are space-saving and variable in both form and width due to the chain's lameller construction
- operate slip-free and quietly with the help of involute-toothing
- ensure functional reliability and a long service life with low wear and tear
- provide versatility through application-specific design
- promote large bearing surfaces and low surface pressure through special link plate forms
- use premium materials for high resistance to temperature and ambient conditions
- offer easy assembly and disassembly due to the chain's specific design
- reduce wear on transported goods through top-quality surfaces
- feature interlocking driving through link plate forms or special drivers

Avoidable problems of various conveyor systems with ...

... belts

Damage due to sharp-edged parts
High degree of wear
Lack of thermal and chemical resistance
Difficult to repair
Complex assembly
Large roller diameter
Large in width
High pre-load forces

... roller conveyors

Loud running noises
Low accuracy
Changing conveyance height
Many individual drives
Lack of interlocking driving
Limited accessibility
Small bearing surface
Missing design variants

... roller chains

Limited width adjustment
Small bearing surface
High surface pressure
High wear with accumulation operation
No immediate driving with accumulation roller chains
Uneven or high elongation
Unbalanced running
Large wheel diameters

Inverted tooth chains from Rexroth—maximum versatility as a modular system.



Using optimized technology

Rexroth inverted tooth conveyor chains offer constant improvement

- New link plate forms for the extended pitch version TRILEG—inverted tooth conveyor chains (see image).
 - Reduced vertical wear caused by abrasion on the teeth across the entire chain.
 - 30 % reduction in pressure and sliding loads.
 - Advantage of lower chain elongation for inverted tooth conveyor chains with extended pitch due to minimizing the number of joints is not impaired.
- The axle pivots in Rexroth's inverted tooth conveyor chains are laser-welded to the outer link plates.
 - Smooth contact surfaces on both sides. Since the rivet heads no longer protrude, inverted tooth conveyor chains may be routed directly along the guide rails.
 - Increase in service life. What doesn't protrude cannot be damaged!
 - Pivot pins do not drift laterally.
 - Substantially larger side surfaces without sharp-edged rivet heads prevent side wear on tooth chains and guide rails.
 - These new inverted tooth chains are fully compatible with existing models. No modifications or sprocket reworking is necessary.

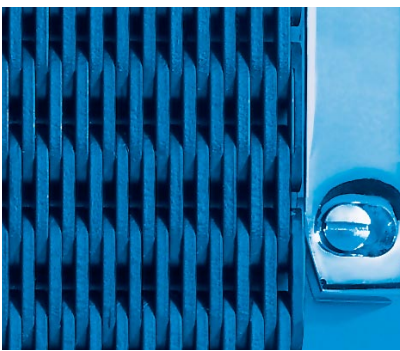

Laser-welded

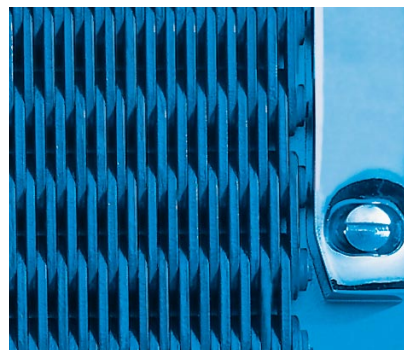

Riveted

Length behaviors of inverted tooth chains, one- and two-pin versions

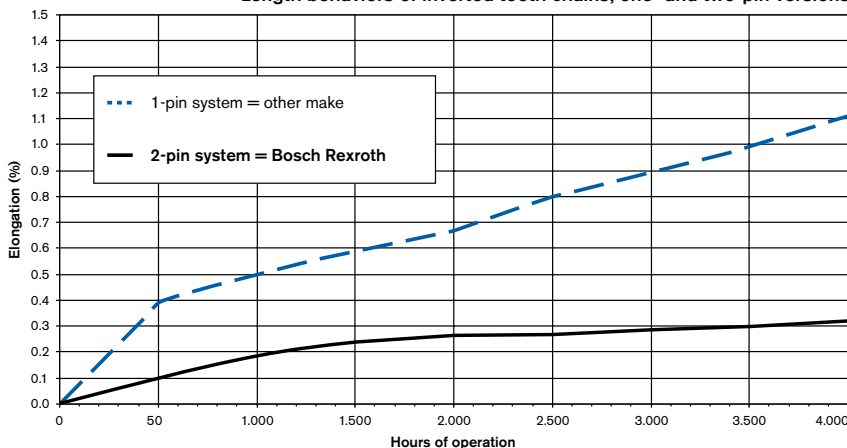

Rexroth joint systems

All one-pin systems experience up to three times as much elongation due to sliding friction. This leads to increased pivot wear. Rexroth's 2-part rolling pivot joint with its tempered pivot and axle pivots creates only rolling friction and thus substantially reduces wear.

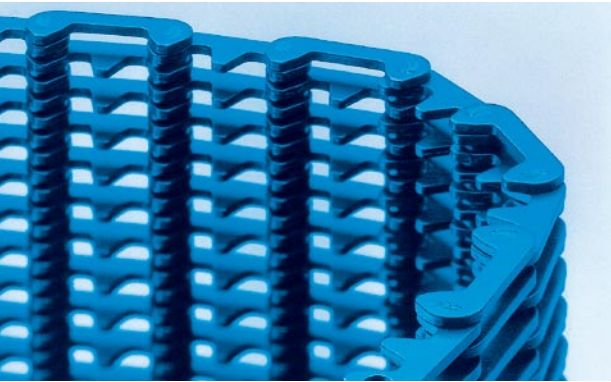

Inverted tooth chains with a 2-part rolling pivot joint constitute the inverted tooth conveyor chains with the least amount of wear due to elongation. Thanks to optimized link plate forms, they also provide an enlarged sliding area.

All models are available in the following standard variations:

- Tight link construction
- Loose link construction with spacer disks or bushings

Additional versions for special applications:

- Inverted tooth chains with smoothed backs for fragile surfaces, for use in accumulation operation and for improved stability (smoothed on both sides upon request)
- Inverted tooth chains made from stainless steel (1.4301) for demanding ambient conditions
- Inverted tooth chains with galvanized or nickel-plated links
- Inverted tooth chains with drivers or special link plates to fit individual conveying needs

Design characteristics

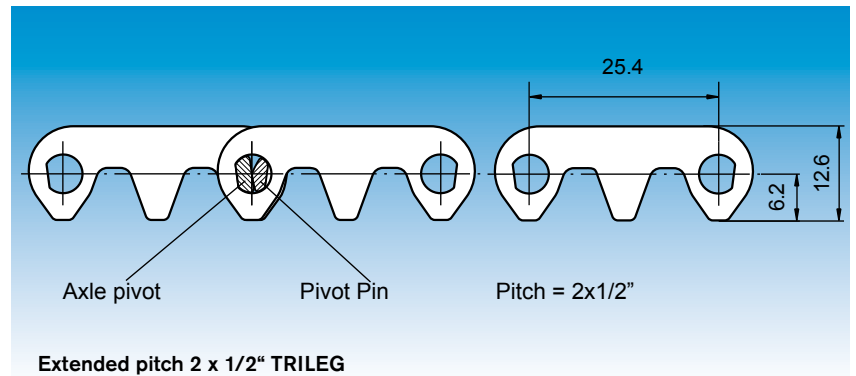

Extended pitch 2 x 1/2" TRILEG

- Less elongation due to wear
- Less vertical wear in the TRILEG version
- Reduced weight allows for easier assembly and less drive energy
- Improved oil and chip removal

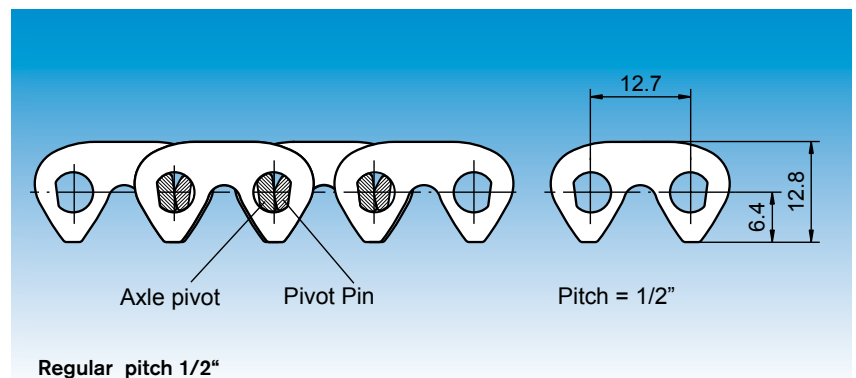

Regular pitch 1/2"

- Can be used for smaller parts
- Universally applicable, especially for smaller return drum diameters
- Compact, durable, and stable under load

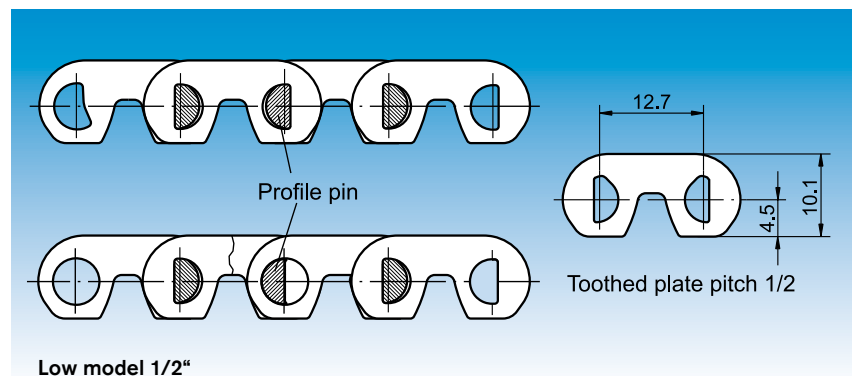

Low model 1/2"

- Extremely large bearing area on the tooth side
- Robust version with a profile pin
- Reduced link height
- Special version without rigid backing available

Types of standard guides

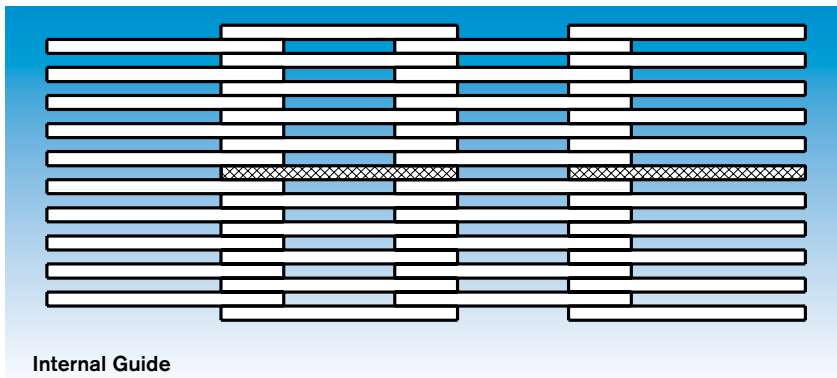

Internal Guide

The middle of the inverted tooth chain contains a row of guide plates which run into a guideway in the wheel and thus center the chain. ■ All-purpose, independent of the existing wheel width.

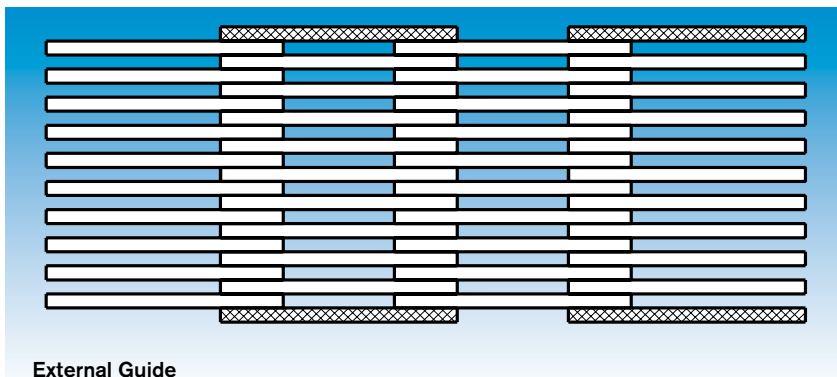

External Guide

The inverted tooth chain displays a row of guide plates which enclose the cogs and center the chain. ■ A completely homogenous link plate formation in the chain's middle is possible. ■ Adjustment to wheel width necessary.

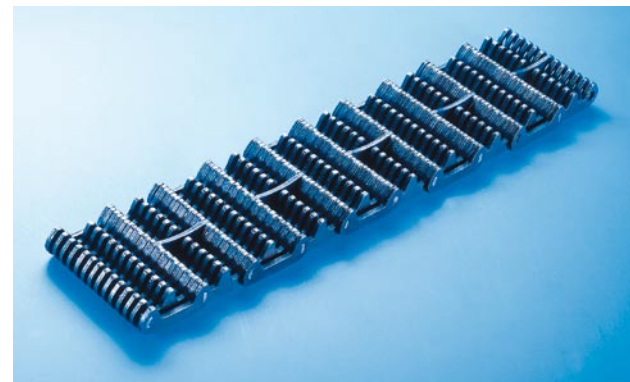

Inverted tooth chains are usually centered on the chain wheel with unmeshed link plates, also known as guide plates. In general, all types of guides have their advantages, and in some circumstances, the guide plates in inverted tooth conveyor chains may be dispensed with completely.

Please ask us for more information.

It goes without saying that all of our standard guide types are available at the same conditions. For all external guide variants, please indicate the meshing width.

A brief overview of the variety of standard designs:			
End version	Link plate type	Construction	Guide
Inverted tooth conveyor chains In machine-specific widths, lengths, material type and with special modifications	Extended pitch TRILEG with two-pin system	tight	internal
		loose	external
	Regular pitch with two-pin system	tight	internal
		loose	external
	Low model with one-pin system	tight	internal
		loose	external

The right layout: a pre-requisite for a long service life

The chain width is measured according to the traction necessary to overcome friction. This friction may be doubled in accumulation zones. The collapse load of an inverted tooth chain should also be considered when extremely heavy weight loads are involved. In case of doubt, please send us your layout. We're happy to assist you!

The actual power requirement can also be determined for a specified conveying speed. In order to prevent an overload caused by oversized motors, the final chain selection is recommended based on the existing drive torque.

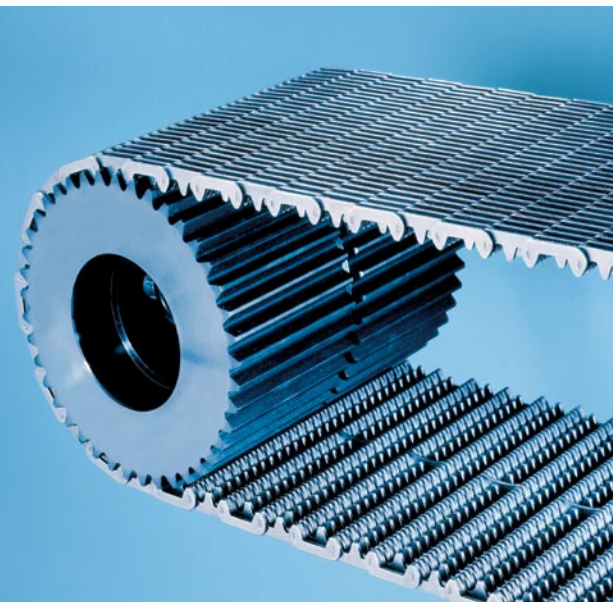

$$F_1 = 9.81 \cdot G \cdot \mu \cdot N_R$$

$$P_{\text{eff}} = F_1 \cdot v \cdot 10^{-3}$$

$$F_2 = \frac{2 \cdot M_d}{d_K} \cdot 10^{-3} \geq F_1$$

Whereby:

F_1 = traction [N]
 G = conveyed weight [kg]
 μ = friction factor, dry sliding friction up to 0.15 adhesion/synthetics up to 0.4
 N_R = number of normal friction surface pairs: $N_R = 1$ loaded chains in accumulation zones: $N_R = 2$
 P_{eff} = effective power requirement [kW]
 v = conveying speed [m/s]
 M_d = torque [Nm]
 d_K = tip diameter [mm]

The selection of an inverted tooth conveyor chain is based on the calculation of the chain's width, which follows the formula:

$$b_a = \frac{F_{1,2} \cdot y}{10 \cdot p \cdot N_z}$$

Whereby:

b_a = chain width [mm]
 $F_{1,2}$ = traction force [N]
 y = length factor for $A = 5$ m and above according to the formula:
 $y = 1.0 + (A - 5) \cdot 0.06$
 with A = shaft distance [m]
Max. value 2.0!
 p = chain pitch 12.7 [mm]*
 N_z = number of chains

*Must also be used for an extended pitch of 2 x 1/2".

Important: The calculated chain width only applies to chains with a tight link plate construction. If choosing an inverted tooth conveyor chain with a loose construction, e.g. with disks or bushings, please ask for a consultation first. In general, special link plates do not affect the width and are described in further detail on page 15. **The determined working width b_a must be doubled for rustproof inverted tooth conveyor chains.**

The chains slide along rails. Metal or synthetic materials are customarily used as wear surfaces and should be accounted for when determining the value μ . A distortion of the bearing area (e.g. placed under pressure during longer downtimes) could result in an increased breaking torque ($\mu = 0.4$) when synthetic materials are involved. (See page 18 for more details on slide rails.)

Explanations:

Factor y : Extra lengths are necessary to prevent the "stick-slip" effect on longer stretches, which may occur as a jerky slide at the end of the conveyor. The calculated width should first be rounded up to an existing working width b_a (taken from the table), depending on type and pitch. For laser-welded inverted tooth conveyor chains, the total width b_g corresponds to the working width.

A simple calculation is important

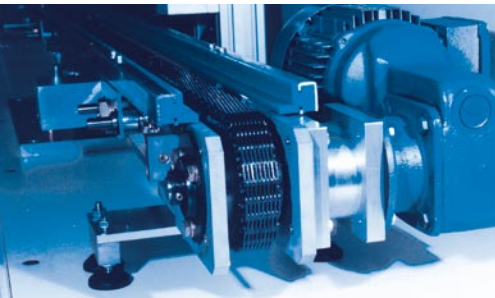
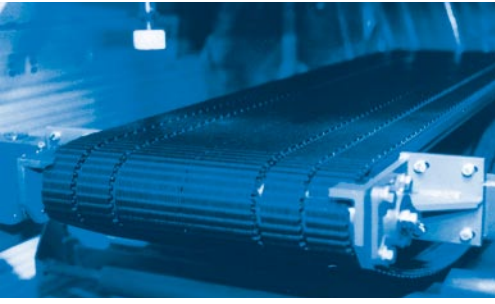

Please keep in mind that both the diagram and the calculation formula contain type-specific data which CANNOT be applied to other models. Only tight inverted tooth chain widths are regarded here. Please contact us concerning versions with spacer disks or bushings.

$$L_{\text{req}} = \frac{100 \cdot G}{b_a \cdot N_z \cdot G_{\text{spec}}}$$

Whereby:

L_{req} = required surface length [mm]
 G = conveyed weight [kg]
 b_a = required chain width [mm] (from calculations on page 8)
 N_z = number of chains
 G_{spec} = specific surface load [kg/mm²] (from the diagram)

Selecting sliding materials

The permissible specific pressure load plays a key role when it comes to selecting sliding materials. Ambient conditions such as temperature, humidity, dust, etc. greatly influence this choice.

The following materials are used:

- PE and PA synthetic materials similar to DIN 7728
- Spring band steel 55 or 65 Si7 or CK 75 (hardened and tempered)

For these most-often used or recommended materials, the required bearing length is roughly determined in the following. It depends on the inverted tooth chain type and may not exceed the permissible pressure load that has been determined for the working width.

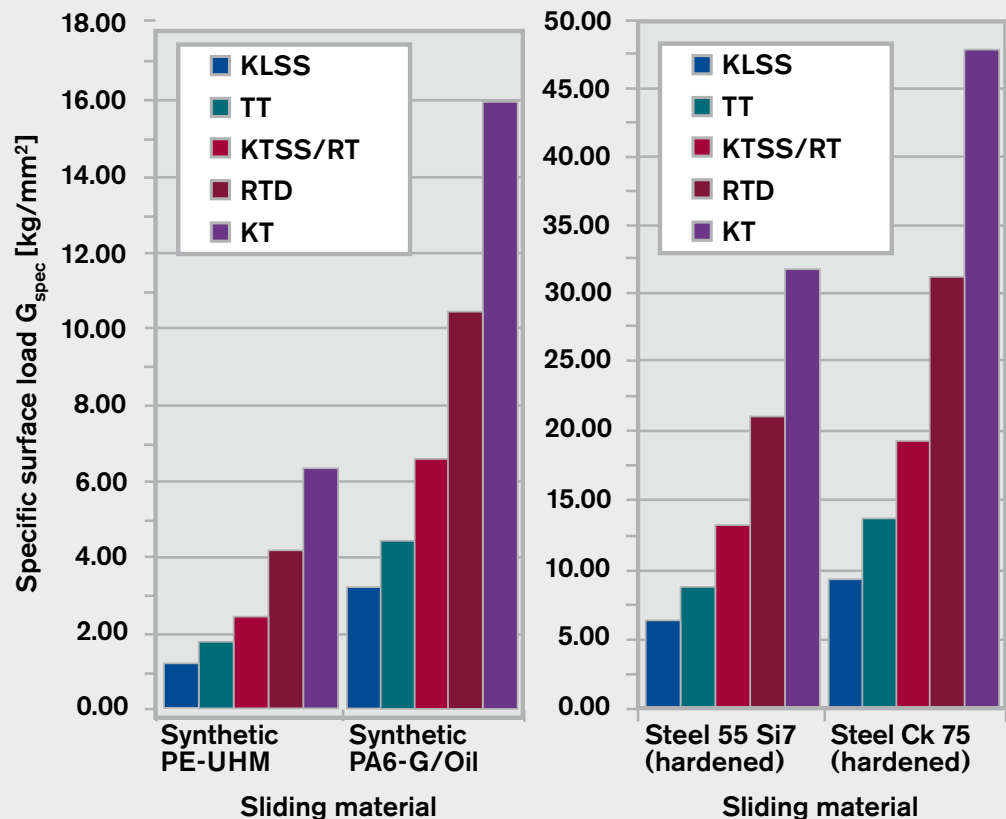

Inverted tooth conveyor chains 2 x 1/2" with two-pin system

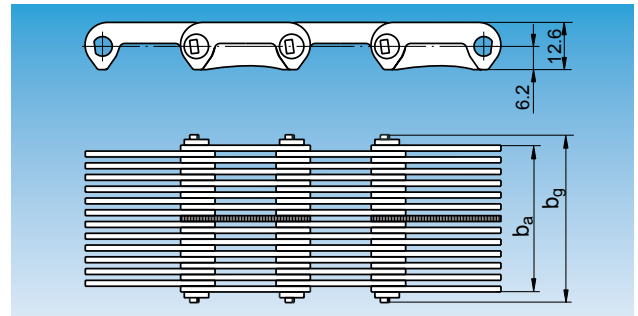
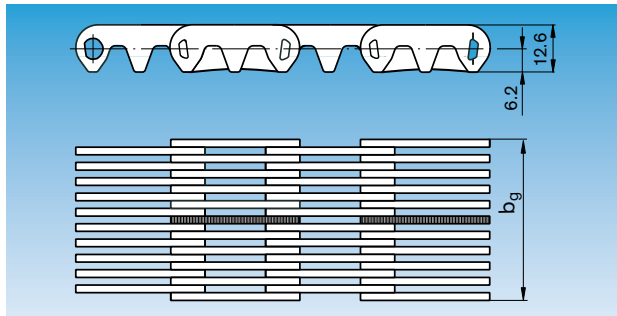

Laser-welded—2 mm link plates			Riveted—1.5 mm link plates				General	
Designation	Max. width b_g	Weight [kg/m]	Designation	Max. working width b_a	Max. total width b_g	Weight [kg/m]	Nom. width	Wheel width b
TT-12-SL	14.5	0.7	KLSS 312 A	9.4	18.1	0.6	12	9.5/8.5
TT-15-SL	18.6	0.9	KLSS 315 A	12.5	21.3	0.7	15	13.5/11.5
TT-20-SL	22.7	1.1	KLSS 320 A	18.8	27.5	0.9	20	17.5
TT-25-CL	26.8	1.2	KLSS 325	26.6	32.2	1.1	25	30
TT-30-CL	31.0	1.4	KLSS 330	29.7	35.3	1.2	30	35
TT-35-CL	35.1	1.6	KLSS 335	36.0	41.6	1.4	35	40
TT-40-CL	39.2	1.8	KLSS 340	42.3	47.9	1.7	40	45
TT-45-CL	43.4	2.0	KLSS 345	45.4	51.0	1.8	45	50
TT-50-CL	51.6	2.3	KLSS 350	51.6	57.2	2.0	50	55
TT-55-CL	55.8	2.5	KLSS 355	54.8	60.4	2.2	55	60
TT-60-CL	59.9	2.7	KLSS 360	61.0	66.6	2.4	60	65
TT-65-CL	64.0	2.9	KLSS 365	64.2	69.8	2.5	65	70
TT-70-CL	68.1	3.1	KLSS 370	70.4	76.0	2.8	70	75
TT-75-CL	76.4	3.4	KLSS 375	76.7	82.3	3.0	75	80
TT-80-CL	80.5	3.6	KLSS 380	79.8	85.4	3.1	80	85
TT-85-CL	84.7	3.8	KLSS 385	86.1	91.7	3.4	85	90
TT-90-CL	88.8	4.1	KLSS 390	89.2	94.8	3.5	90	95
TT-95-CL	97.1	4.3	KLSS 395	95.5	101.1	3.7	95	100
TT-100-CL	101.2	4.5	KLSS 3100	101.7	107.3	4.0	100	105
TT-115-CL	117.7	5.2	KLSS 3115	114.2	119.8	4.4	115	120
TT-125-CL	126.0	5.6	KLSS 3125	126.8	132.4	4.9	125	130
TT-140-CL	138.4	6.2	KLSS 3140	139.3	144.9	5.4	140	145
TT-150-CL	150.7	6.7	KLSS 3150	151.8	157.4	5.9	150	155
TT-175-CL	175.5	7.8	KLSS 3175	176.8	182.4	6.8	175	180
TT-200-CL	200.3	8.9	KLSS 3200	201.9	207.5	7.8	200	205
TT-250-CL	249.9	11.1	KLSS 3250	252.0	257.6	9.7	250	255
TT-300-CL	299.4	13.3	KLSS 3300	302.0	307.6	11.7	300	305

Measurements are in millimeters—for sprocket specifications, please see pages 16 und 17.

Modifications:

- Loose construction with spacer disks or spacer bushings
- With smoothed surface or smooth on both sides
- Slip-smoothed
- Integration of driver plates
- Additional widths available upon request

Use only even link numbers. Number of links equals number of pitches. The manufacturing tolerance for the working width and total width is -1%.

Note: Inverted tooth chains are delivered with a riveted closure. When using split pin fasteners, bear in mind the protruding pin head on one side.

Inverted tooth conveyor chain 1/2" with two-pin system

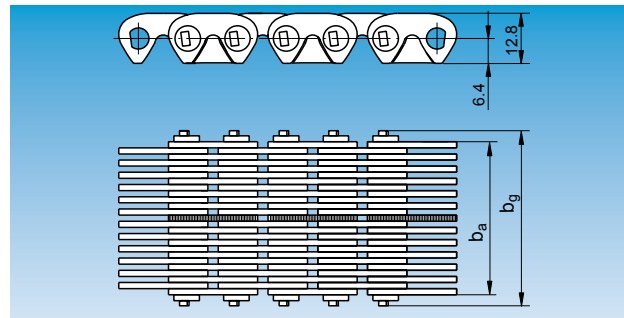
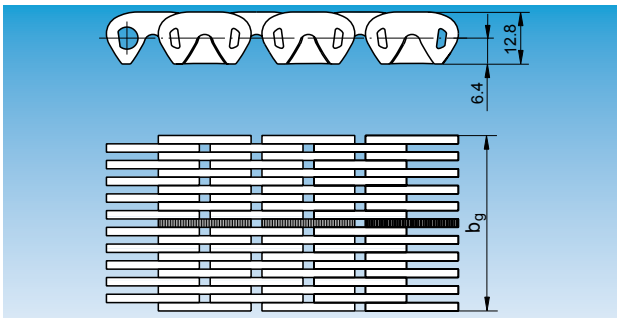

Laser-welded—2 mm link plates			Riveted—1.5 mm link plates				General	
Designation	Max. width b_g	Weight [kg/m]	Designation	Max. working width b_a	total width b_g	Weight [kg/m]	Nom. width	Wheel width b
RT-12-SL	14.5	0.9	KTSS 312 A	9.4	18.1	0.8	12	9,5/8,5
RT-15-SL	18.6	1.1	KTSS 315 A	12.5	21.3	1.0	15	13,5/11,5
RT-20-SL	22.7	1.4	KTSS 320 A	18.8	27.5	1.4	20	17,5
RT-25-CL	26.8	1.6	KTSS 325	26.6	32.2	1.6	25	30
RT-30-CL	31.0	1.9	KTSS 330	29.7	35.3	1.8	30	35
RT-35-CL	35.1	2.1	KTSS 335	36.0	41.6	2.2	35	40
RT-40-CL	39.2	2.4	KTSS 340	42.3	47.9	2.5	40	45
RT-45-CL	43.4	2.6	KTSS 345	45.4	51.0	2.7	45	50
RT-50-CL	51.6	3.1	KTSS 350	51.6	57.2	3.1	50	55
RT-55-CL	55.8	3.3	KTSS 355	54.8	60.4	3.3	55	60
RT-60-CL	59.9	3.6	KTSS 360	61.0	66.6	3.6	60	65
RT-65-CL	64.0	3.8	KTSS 365	64.2	69.8	3.8	65	70
RT-70-CL	68.1	4.1	KTSS 370	70.4	76.0	4.2	70	75
RT-75-CL	76.4	4.5	KTSS 375	76.7	82.3	4.5	75	80
RT-80-CL	80.5	4.7	KTSS 380	79.8	85.4	4.7	80	85
RT-85-CL	84.7	5.0	KTSS 385	86.1	91.7	5.1	85	90
RT-90-CL	88.8	5.4	KTSS 390	89.2	94.8	5.2	90	95
RT-95-CL	97.1	5.7	KTSS 395	95.5	101.1	5.6	95	100
RT-100-CL	101.2	5.9	KTSS 3100	101.7	107.3	6.0	100	105
RT-115-CL	117.7	6.9	KTSS 3115	114.2	119.8	6.7	115	120
RT-125-CL	126.0	7.4	KTSS 3125	126.8	132.4	7.4	125	130
RT-140-CL	138.4	8.1	KTSS 3140	139.3	144.9	8.1	140	145
RT-150-CL	150.7	8.8	KTSS 3150	151.8	157.4	8.8	150	155
RT-175-CL	175.5	10.3	KTSS 3175	176.8	182.4	10.3	175	180
RT-200-CL	200.3	11.7	KTSS 3200	201.9	207.5	11.7	200	205
RT-250-CL	249.9	14.6	KTSS 3250	252.0	257.6	14.6	250	255
RT-300-CL	299.4	17.4	KTSS 3300	302.0	307.6	17.5	300	305

Measurements are in millimeters—for sprocket specifications, please see pages 16 und 17.

Modifications:

- Loose construction with spacer disks or spacer bushings
- With smoothed surface or smooth on both sides
- Slip-smoothed
- Integration of driver plates
- Additional widths available upon request

Use only even link numbers. Number of links equals number of pitches. The manufacturing tolerance for the working width and total width is -1%.

Note: Inverted tooth chains are delivered with a riveted closure.

When using split pin fasteners, bear in mind the protruding pin head on one side.

Inverted tooth conveyor chain 1/2" with one-pin system

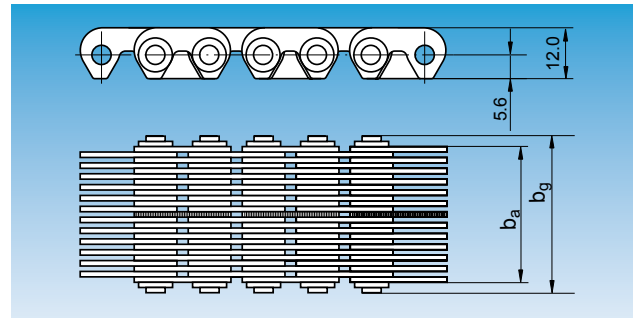
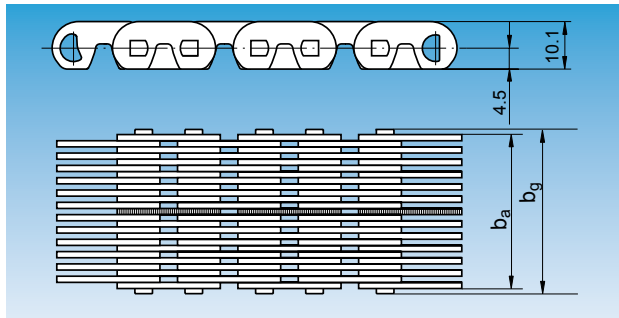

Low model–1.5 mm link plates				Rustproof–1.5 mm link plates				General	
Designation	Max. working width b_a	Max. total width b_g	Weight [kg/m]	Designation	Max. working width b_a	Max. total width b_g	Weight [kg/m]	Nom. width	Wheel width b
KT 312 A	9.4	15.1	0.7	RTD 312 A	9.4	18.5	1.2	12	8.5
KT 315 A	12.5	18.3	0.9	RTD 315 A	12.5	21.7	1.4	15	11.5
KT 320 A	17.2	22.9	1.1	RTD 320 A	17.2	26.3	1.7	20	16.0
KT 325	26.6	29.2	1.1	RTD 325	26.6	32.6	2.0	25	30.0
KT 330	29.7	32.3	1.6	RTD 330	29.7	35.7	2.2	30	35.0
KT 335	36.0	38.6	1.9	RTD 335	36.0	42.0	2.6	35	40.0
KT 340	42.3	44.9	2.2	RTD 340	42.3	48.3	2.9	40	45.0
KT 345	45.4	48.0	2.3	RTD 345	45.4	51.4	3.1	45	50.0
KT 350	51.6	54.2	2.7	RTD 350	51.6	57.6	3.5	50	55.0
KT 355	54.8	57.4	2.8	RTD 355	54.8	60.8	3.7	55	60.0
KT 360	61.0	63.6	3.1	RTD 360	61.0	67.0	4.0	60	65.0
KT 365	67.3	69.9	3.4	RTD 365	67.3	73.3	4.4	65	70.0
KT 370	70.5	73.1	3.6	RTD 370	70.5	76.5	4.6	70	75.0
KT 375	75.1	77.7	3.8	RTD 375	75.1	81.1	4.8	75	80.0
KT 380	79.8	82.4	4.1	RTD 380	79.8	85.8	5.1	80	85.0
KT 385	86.1	88.7	4.4	RTD 385	86.1	92.1	5.5	85	90.0
KT 390	89.2	91.8	4.5	RTD 390	89.1	95.1	5.7	90	95.0
KT 395	95.5	98.1	4.9	RTD 395	95.5	101.5	6.1	95	100.0
KT 3100	100.2	102.8	5.1	RTD 3100	100.2	106.2	6.2	100	105.0
KT 3115	114.3	116.9	5.8	RTD 3115	114.3	120.3	7.2	115	120.0
KT 3125	123.6	126.2	6.3	RTD 3125	123.6	129.6	7.7	125	130.0
KT 3140	139.3	141.9	7.0	RTD 3140	139.3	145.3	8.6	140	145.0
KT 3150	148.7	151.3	7.5	RTD 3150	148.7	154.7	9.2	150	155.0
KT 3175	173.7	176.3	8.8	RTD 3175	173.7	179.7	10.6	175	180.0
KT 3200	198.8	201.4	10.0	RTD 3200	198.8	204.8	12.1	200	205.0
KT 3250	248.8	251.4	12.6	RTD 3250	248.8	254.8	15.0	250	255.0
KT 3300	298.9	301.5	15.0	RTD 3300	298.9	304.9	18.1	300	305.0

Measurements are in millimeters—for sprocket specifications, please see pages 16 and 17.

Modifications:

- Loose construction with spacer disks or spacer bushings
- With smoothed surface or smooth on both sides
- Slip-smoothed
- Integration of driver plates
- Additional widths available upon request

Use only even link numbers. Number of links equals number of pitches. The manufacturing tolerance for the working width and total width is -3%.

Note: Inverted tooth chains are delivered with a riveted closure.

When using split pin fasteners, bear in mind the protruding pin head on one side.

*Applies only to low model.

Inverted tooth conveyor chain 1"

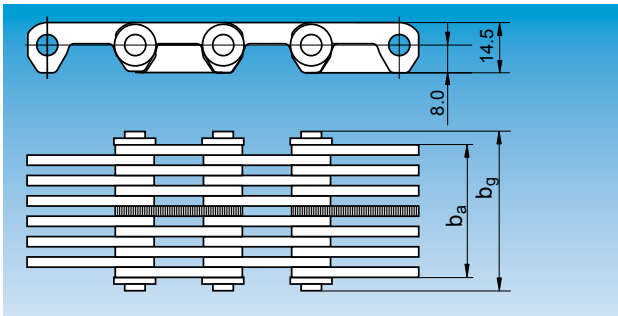

Low model—3 mm link plates (one-pin system)

Designation	Max. working width b_a	Max. total width b_g	Weight [kg/m]	Nom. width	Wheel width b
LCC 6200	198	206	10.0	200	210
LCC 6250	247	255	12.4	250	260
LCC 6300	302	310	15.2	300	310
LCC 6350	351	359	17.6	350	360
LCC 6400	400	408	20.1	400	410
LCC 6450	449	457	22.5	450	460
LCC 6500	497	505	25.0	500	510

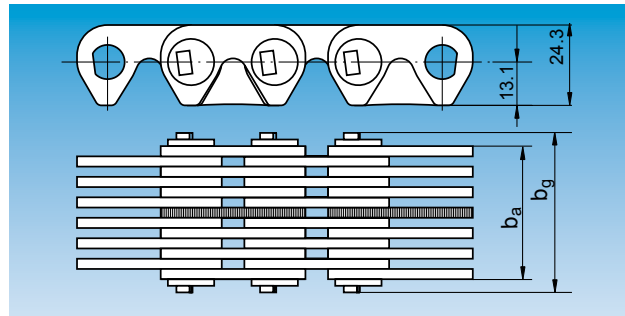

Normal model—3 mm link plates (two-pin system)

Designation	Max. working width b_a	Max. total width b_g	Weight [kg/m]	Nom. width	Wheel width b
KT 630	27.9	35.9	3.4	30	35
KT 640	40.2	48.2	4.7	40	45
KT 650	52.6	60.6	6.1	50	55
KT 675	77.4	85.4	8.8	75	80
KT 6100	102.1	110.1	11.5	100	105
KT 6125	126.9	134.9	14.2	125	130
KT 6150	151.7	159.7	17.3	150	155

Measurements are in millimeters—for sprocket specifications, please see pages 16 und 17.

Modifications:

- Loose construction with spacer disks
- With smoothed surface or smooth on both sides
- Integration of driver plates or milled driver blocks
- Additional widths available upon request

Use only even link numbers. Number of links equals number of pitches. The manufacturing tolerance for the working width and total width is -2%.

Note: Inverted tooth chains are delivered with a riveted closure.

When using split pin fasteners, bear in mind the protruding pin head on one side.

For especially heavy operation, inverted tooth conveyor chains with 1" pitches are available: type LCC with a low construction and type KT 6..

Due to its robust link geometry, the LCC type is especially well suited for greater widths and its bending capability over the chain back is almost unlimited (no rigid backing).

Type KT 6.. differs from other 1" drive tooth chains in that the link plate backs as well as the teeth have been leveled. As a result, these link plate forms provide the best conditions for transporting heavy workpieces together with the especially low-wear rolling pivot joint. This version also acts as a friction drive for the precise synchronization of sheet glass transfer rolls.

Order codes for inverted tooth conveyor chains

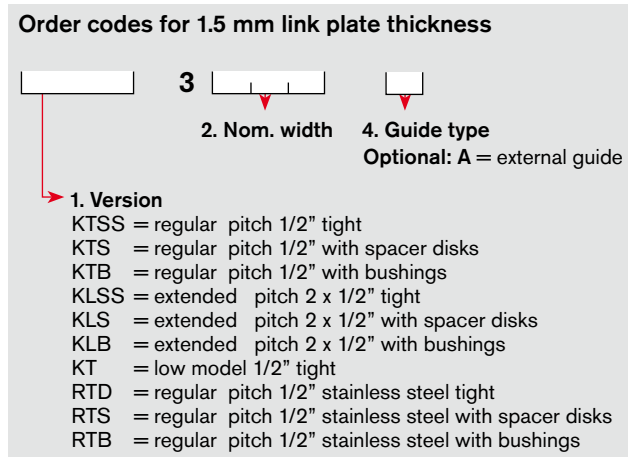
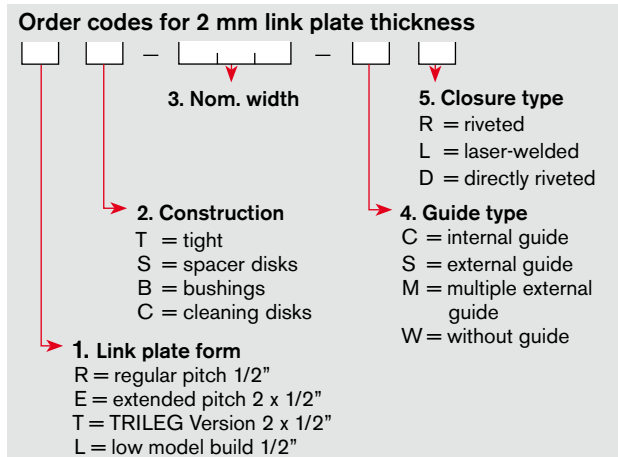

The standard inverted tooth chains contained in the chart present a selection of our product range. Laser-welded inverted tooth conveyor chains include two additional rivet closures for servicing.

If not explicitly stated, all inverted tooth chains—with the exception of the low model which is riveted directly—are manufactured with riveted disks.

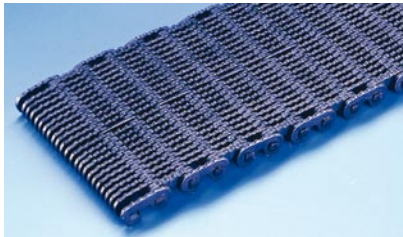

Ridged surfaces for slip-free wood transport



Precision plate chain mounted on an inverted tooth chain base



Drag chain to couple transport trolleys



Cycle line with massive driver blocks



Stable driver coupling



Driver link plates for cross-bars



Improved precision with punched ring links

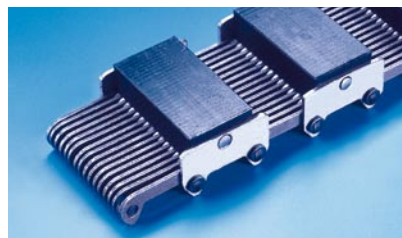

Plastic carriers for sensitive workpiece surfaces

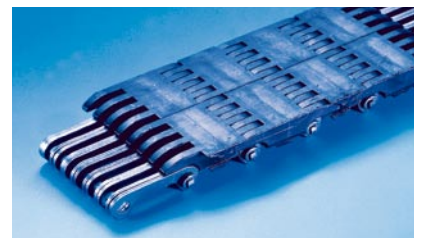

Plastic clips for complete coverage of the inverted tooth chain

We are used to the unusual.

Specially designed inverted tooth chains

Special link plates further expand the area of inverted tooth chain applications.

Various possibilities exist:

- Special inverted tooth chains made entirely from special link plates, e.g. ring or forked plates to take up cross-bars or link plates with ridged backs for wood transport
- Special link plates only at certain positions, e.g. for fastening mold halves on packaging lines or, on both sides of the chain, fastening link on a support ring to serve as a toothed ring

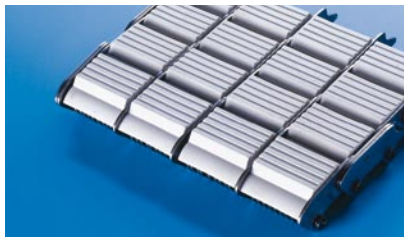
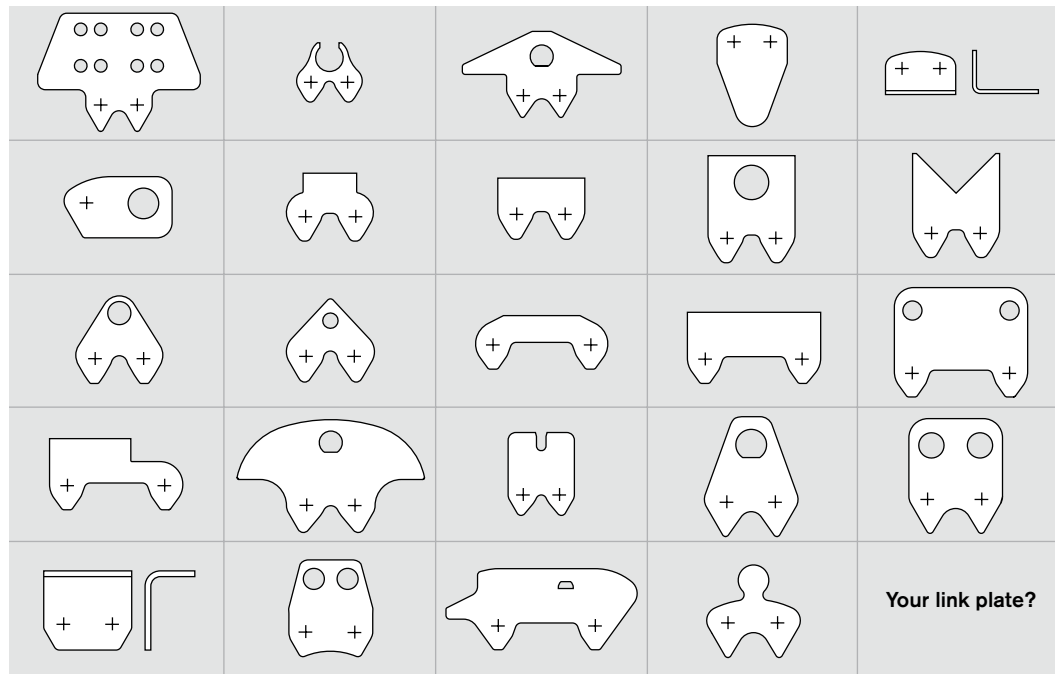

Ceramic items for an inverted tooth chain cover in hot areas

- Special inverted tooth chains with extra parts, e.g. massive driver blocks for cycle lines, welded disks for precise plate conveyors, or plastic or ceramic components for the bearing surface

There is a large selection of existing special link plates. Additional forms can be produced quickly through laser cutting.



Link plate package with integrated longitudinal profile

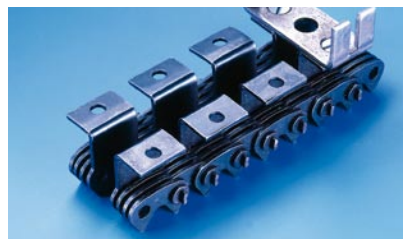

Workpiece supports for light bulb elements



Prism inverted tooth chain with plastic link plates for centering profile rods



Inverted tooth chain in mirrored pairs for packaging lines



Inverted tooth chain in mirrored pairs for outfeed lines



Inverted tooth chain with clamping bolts as toothed ring segment

The right sprockets for each task

Task-specific inverted tooth conveyor chain versions are just as multifaceted as the proper sockets. Optimal adaptation of all relevant dimensions and profiles to one another results in an accurate tothing, the first step to trouble-free continuous operation.

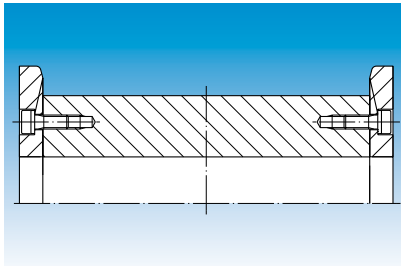
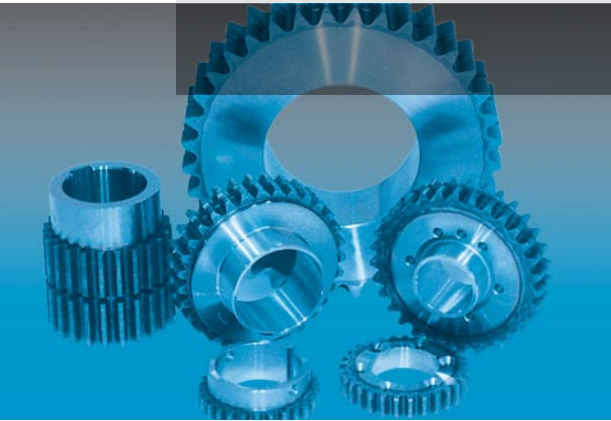

Slide rail height

Raising the rail surface by 2% of the sprocket diameter reduces contact pressure on the teeth and promotes quiet running.

Whereas regular and extended pitch share an identical tothing profile, the low model has its own tothing profile. Sprockets are manufactured according to customer's visions as far as technically possible. Tooth formation is adjusted to the guide version of the selected inverted tooth chain. When ordering replacement sprockets for existing external guide chains, please indicate the type and current tothing width.

To ensure constant belt height at transfer points, we also offer customer-specific solutions for return rollers without tothing where the external diameter including the chain corresponds to the sprockets currently in use. The chain can then be guided with hardened flanged wheels mounted on both sides.

The total width of the inverted tooth chain must be accounted for. When used in laser-welded inverted tooth conveyor chains, return rollers with flanged wheels enjoy a much longer service life thanks to reduced wear.

Usually, C45 steel sprockets with hardened tooth flanks are supplied. Although other materials are possible, steel wheels are preferred for up to 30 teeth.

The reference diameter helps determine the correct external diameter of the sprocket with an attached chain in new condition.

Pitch diameter:

$$PD = \frac{P}{\sin(180^\circ/z)}$$

Max. diameter w. inverted tooth chain:

$$D_{\max} = PD + X$$

Recommended slide rail height:

$$h_{\text{slide}} \approx (PD \cdot 1.02)/2 - o$$

Pitch	Design	Factor X	Value o
1/2"	Regular	12.8	6.4
	Extended	12.8	6.2
	Low	11.2	4.5
1"	Regular	22.4	13.1
	LCC	13.0	8.0

Sprocket dimensions

For 1/2" wheels, different tooth widths apply to the two chain pivot constructions. Sprocket orders must specify whether inverted tooth chains will use a one- or two-pin system.

Chain width determines sprocket width. Narrower sprocket widths are possible in special cases. Extremely wide chains may make use of a series of narrower disks positioned side by side at a distance.

Sprockets with proper tothing are a pre-requisite for the chain's reliable functioning and long service life. The guarantee for inverted tooth chains does not apply to wheels of foreign make.

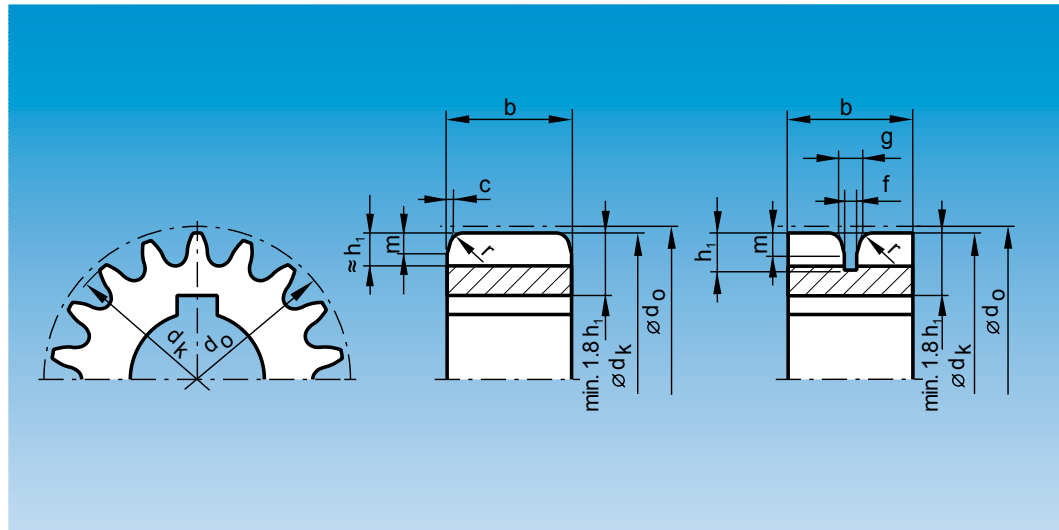

Sprockets

Pitch	1/2"		All	1"	
	Design	All		Standard	LCC
No. of teeth	d _o	d _k	d _o	d _k	d _k
12	-	-	98.1	-	94.4
13	-	-	106.1	-	102.7
14	-	-	114.1	-	110.9
15	61.1	59.7	122.2	119.4	119.1
16	65.1	63.8	130.2	127.6	127.3
17	69.1	67.9	138.2	135.8	135.5
18	73.1	72.0	146.3	144.0	143.7
19	77.2	76.1	154.3	152.2	151.8
20	81.2	80.1	162.4	160.3	160.0
21	85.2	84.2	170.4	168.5	168.1
22	89.2	88.3	178.5	176.6	176.3
23	93.3	92.3	186.5	184.7	184.4
24	97.3	96.4	194.6	192.9	192.5
25	101.3	100.5	202.7	201.0	200.7
26	105.4	104.5	210.7	209.1	208.8
27	109.4	108.6	218.8	217.3	216.9
28	113.4	112.7	226.9	225.4	225.0
29	117.5	116.7	234.9	233.5	233.1
30	121.5	120.8	243.0	241.6	241.3
31	125.5	124.8	251.1	249.7	249.4
32	129.6	128.9	259.1	257.8	257.5
33	133.6	133.0	267.2	266.0	265.6
34	137.6	137.0	275.3	274.1	273.7
35	141.7	141.1	283.4	282.2	281.8
36	145.7	145.1	291.4	290.3	289.9
37	149.8	149.2	299.5	298.4	298.0
38	153.8	153.2	307.6	306.5	306.1
39	157.8	157.3	315.7	314.6	314.2
49	198.2	197.8	396.4	395.6	395.2
59	238.6	238.2	477.2	476.5	476.2
69	279.0	278.7	558.1	557.4	557.1
79	319.4	319.1	638.9	638.3	638.0
89	359.9	359.6	719.7	719.2	718.9
99	400.3	400.0	800.6	800.1	799.8

Measurements are in mm - Intermediate values should be interpolated

Guide groove and profile

Pitch	1/2"	1" KT	1" LCC
g	4	8	8
f	3	6	6
h ₁	8	16	12
m	5	10	6
r	2	3	3
c	0.5	1	1

Pitch	Design	Minimum amount of teeth
1/2"	Regular	17
	Extended	26, pref. 35
	Low	15
1"	Regular	15
	LCC	12

From inverted tooth chains and profiles from Rexroth to a complete conveyor line

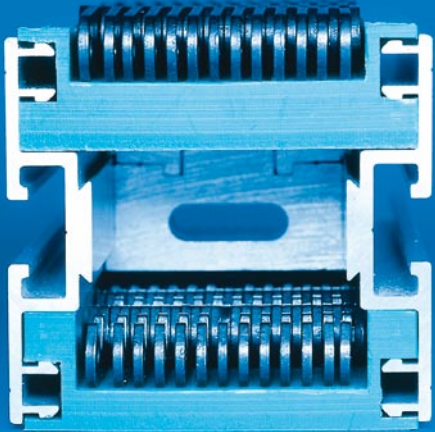

Rexroth profiles make it easy to produce optimum conveyor line segments for every inverted tooth chain width.

The clearance between the inverted tooth chain and the frame must be accounted for. The bases fitted between side parts can be adjusted to fit any width desired. As a result, both the inverted tooth conveyor chain and the corresponding profiles are individually designed for your conveyance needs and facilitate the optimal use of available

space. In addition, the frame may be turned into a complete conveyor with the respective return units. Suitable supports round out the offer.

The correct selection of sliding material substantially increases reliable operation and service life of the inverted tooth chain. Standard profiles for conveyor belts may also be used.

The following minimum requirements apply to inverted tooth chains with 1/2" pitch, depending on the type of closure:

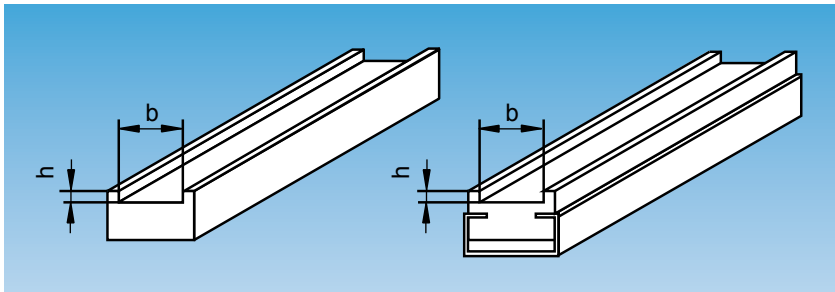

Closure type	h	b
Laser-welded	Link height *)	$bg + 1 \text{ mm}$
With rivet disk	a) 2 mm	a) $ba + 1 \text{ mm}$
or directly riveted	b) Link height *)	b) $bg + 1 \text{ mm}$

(RTD execution of situation a) is NOT permissible)

*) This requires the use of rivet closures. A high lateral guide without laser-welded closure generally implies much higher side wear on the slide rails.

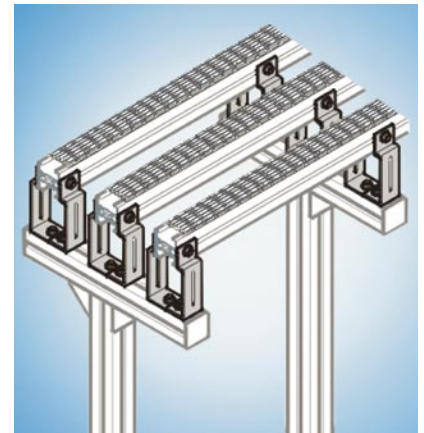

Take advantage of Rexroth's wide range of products.

Installation and maintenance

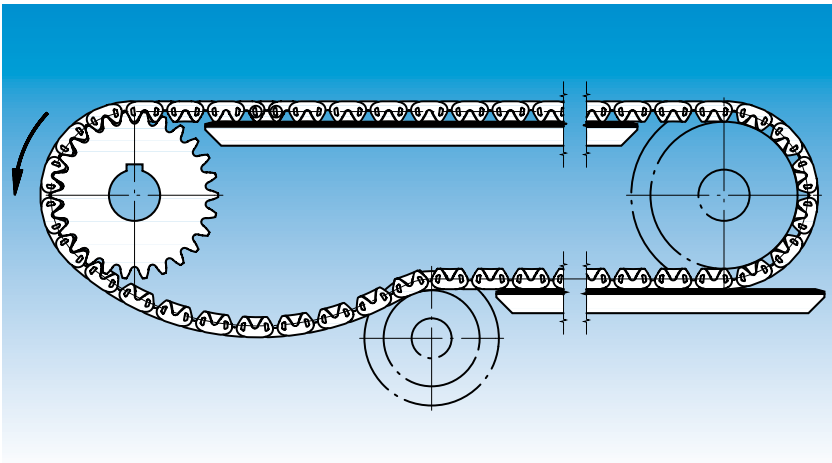

The interlocking drive of inverted tooth conveyor chains eliminates the need for pre-tensioning.

The drive has to be placed in the direction of traction. Re-tensioning usually occurs by adjusting the distance between the axles. If the end of the re-tensioning stretch has been reached, the inverted tooth chain can easily be shortened. Additionally, a self-tensioning effect (due to the chain's own weight) can be expected when a one-meter-long section of the lower belt sags from the drive wheel. As inverted tooth chain drives do not possess much bilateral flexibility, they should be bent gently over the backs. Depending on the pitch and version, the empty side can be returned with appropriate sprockets (see chart). Belts with S-shaped wraps, e.g. with a center drive, are available with bilaterally flexible inverted tooth chains. Reverse operation is possible in a pre-tensioned inverted tooth chain; however, this requires a special layout.

Guiding the inverted tooth chain

Chain guiding takes place on both sides through wedge steel with feed slopes or in a U-shape in commercially available plastic profiles. The right material together with the slide surface is selected according to the intended use. The returning chain section must also be supported in case of intervals of one meter or more between axles, e.g. with sliding surfaces in concave profiles, separate slide rails or supporting rollers. The diameter of these rollers is determined by the type of inverted tooth chain. Laser-welded inverted tooth conveyor chains from Rexroth feature the best lateral guide qualities.

Overview of the allowable bending radii for the return unit:

Inverted tooth chain type	bending radius
KTSS / KTS / KTB	> 35 mm
RT / RS / RB	> 65 mm
KLSS / KLS / KLB	> 75 mm
TT / TS / TB	> 95 mm

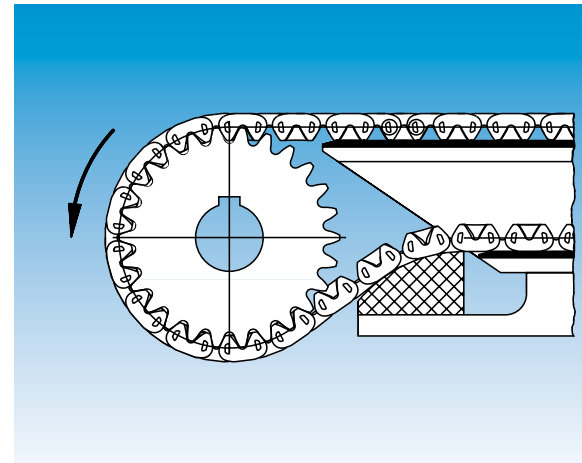

Lubrication

Inverted tooth chains are delivered only corrosion-proof. A thorough initial lubrication must take place before installation. Additional lubrication should follow in longer intervals based on use and intensity. The lubricant should be applied to the chain teeth from the inside. Our product range also includes automatic lubrication units for basic lubrication.

Easy assembly and correct shortening of inverted tooth chains

Use only even link numbers. Otherwise, lateral offsets may develop at the junction between both ends. Normal riveted inverted tooth chains are closed with rivets and may be opened at any point by grinding off a rivet head. A new rivet closure is needed to reseal the opening. The following operation applies to inverted tooth chains with direct riveting or laser-welding:

Closing

- Join both ends and connect them with the accompanying rivet closure.
- For laser-welded inverted tooth chains, grind off any protruding rivet head to the outer link.

Shortening

Fig. 1:

- Force open the weld by hitting the pin's front side (if possible, offset on both sides to allow each support pin to remain connected to a welding link).

Fig. 2:

- Remove the first support pin with the connected welding link and replace it with the rivet closure support pin.
- The pivot pin need not be changed.
- Remove the second support pin likewise with the welding link.
- Rivet.

Fig. 3:

- Measure off the necessary length and disconnect both welds on one side (blasting the link on its front).

Fig. 4:

- Remove welding link with both rolling pivot joints.
- Remove individual parts and single links as well as a chain section.

Fig. 5:

- Push the now inversely arranged ends of the inverted tooth chain into one another as to make the holes congruent.

Fig. 6:

- Insert rivet closure (first the support pin with the disk, then the pivot pin).
- Rivet and abrade both rivet heads until they are flush with the outer surface of the welding link.

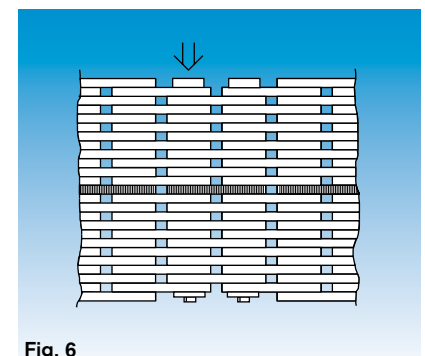
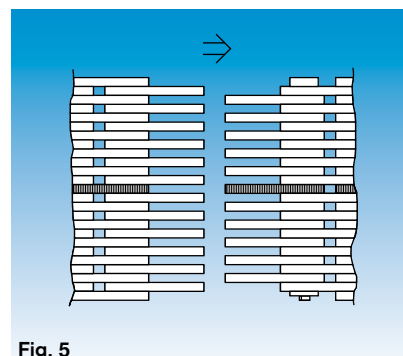
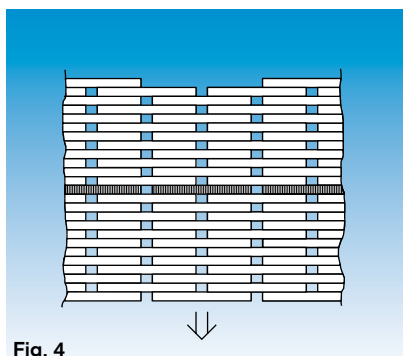
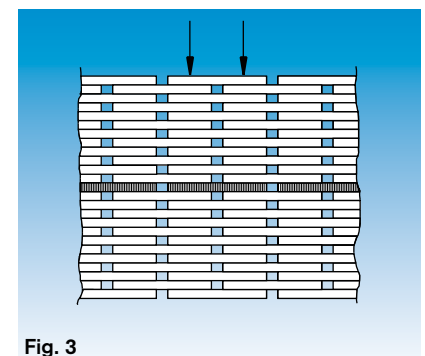
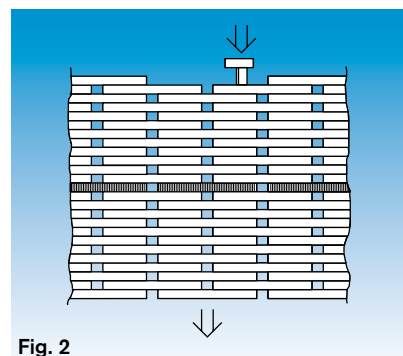
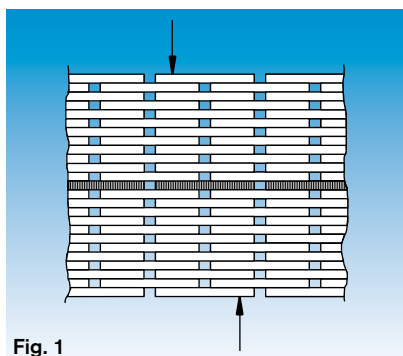

Special features

Auxiliary tools

In order to facilitate the opening of the laser-welded inverted tooth chain, we have developed a tool to clamp the inverted tooth chain and increase the clearance between the link plates on the side to be opened. Thus, a link plate may be removed with a common screwdriver.

Features of inverted tooth chains in a one-pin-system (Type KT)

A weakened structure due to single closures combined with an omission of external link plates is especially undesirable in narrow widths. Therefore, a double-riveted closure is supplied with these versions (e.g. KT 312A).

A pin with an attached but unriveted disk prevents the outer link plates from falling off. The double-riveted closure consists of three individual parts, as shown on the right.

The shortening resembles the laser-welded version, with opening according to Fig. 3. Where necessary, two lower ends must be laid against one another and separated by equal distances. Loose link plates then fill those spaces.

The double-riveted closure is sandwiched in and riveted after insertion of the corresponding outer link plate.

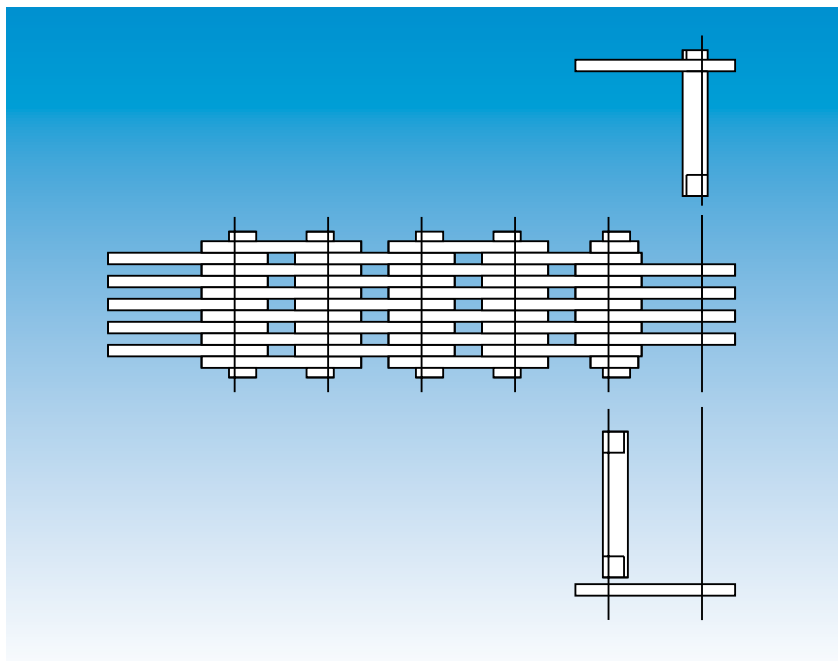
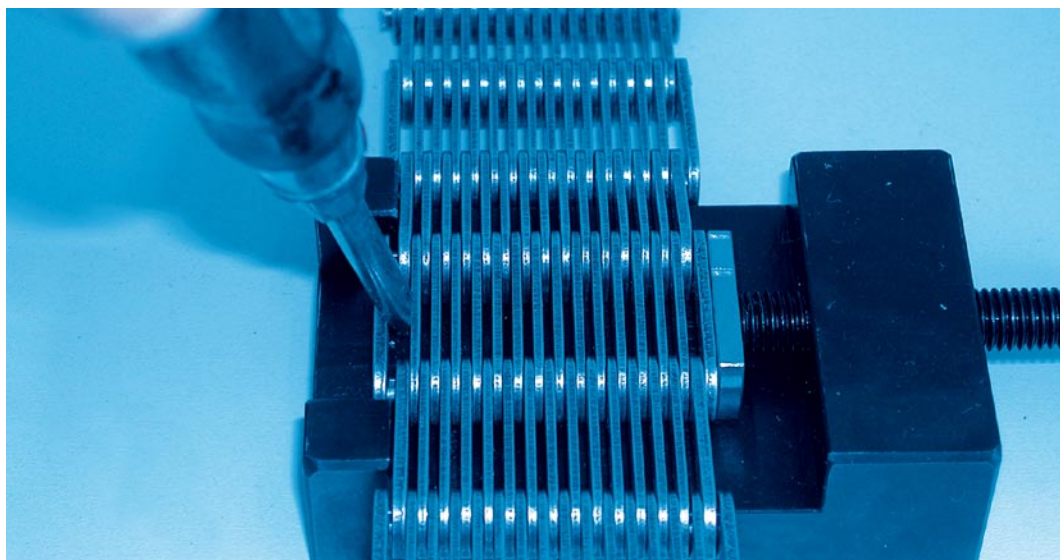

Advantages you can dig your teeth into: Customer service, engineering, design, and extensive know-how.

Using the latest technical methods and field-specific knowledge needed for the customers' tasks, we calculate and develop the most suitable configuration. Inverted tooth chains and sprockets are perfectly adapted to each other.

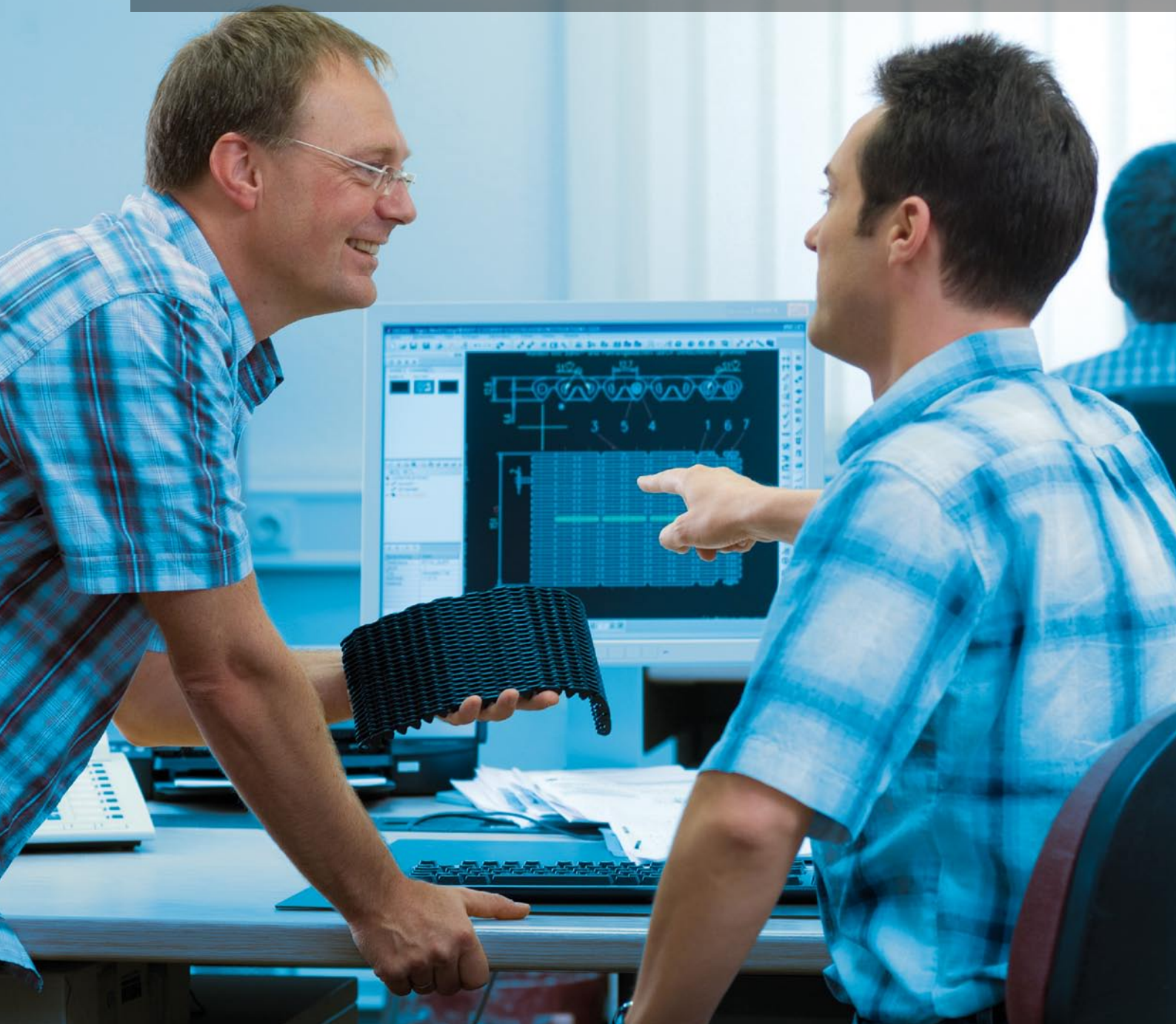

Inverted tooth chains for drives: All inverted tooth chains for conveying and special applications originated in driven tooth-chains.

These were designed for the transmission of great traction, torque, and power, even at high rotations and speeds up to 50 m/s as well as slower-running machines at full capacity. In all of these cases, service life and functional reliability are indispensable.

These factors are met through the following pre-requisites:

- Friction-free rolling pivot joints made from case hardened steel and exhibiting a high degree of efficiency, resistance to wear, and durability
- Inverted tooth chain link plates with FE-optimized outlines made from high-resistance heat-treated steel
- Sprockets featuring hardened involute-toothing for smooth, impact-free meshing

When compared to other wrap drives, steel pivot drives, and belt drives, the advantages shine through:

- Optimum use of space due to high power density
- **The proverbial quiet running; in a word: silent chain**
- Extremely long service life
- Very low lubrication requirements
- High temperature tolerance

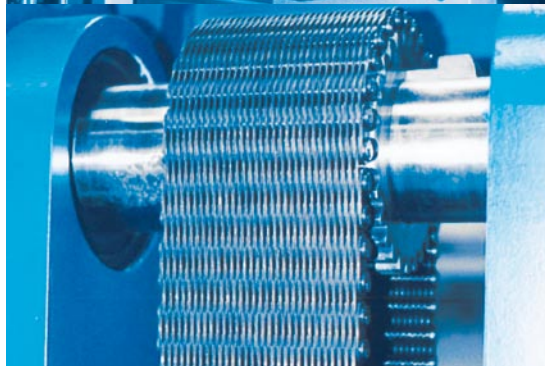
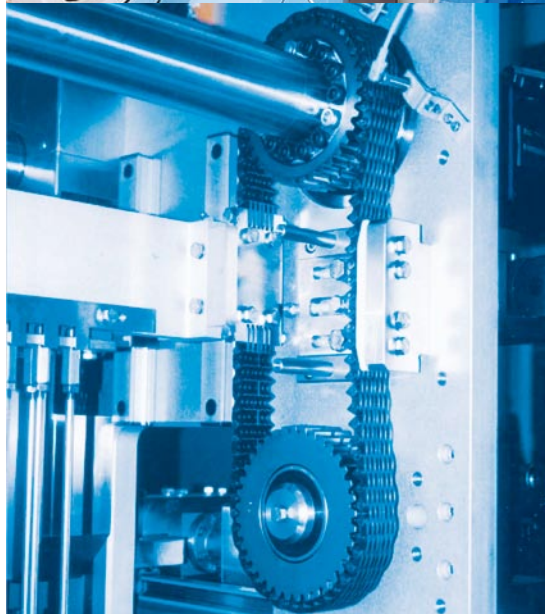
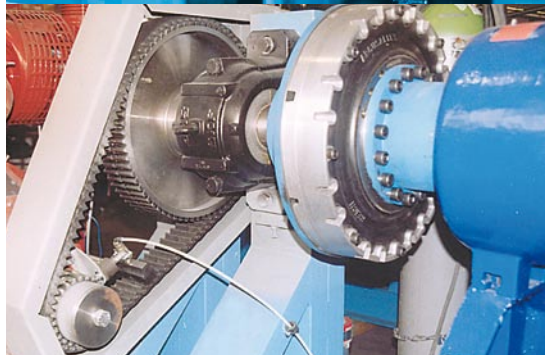
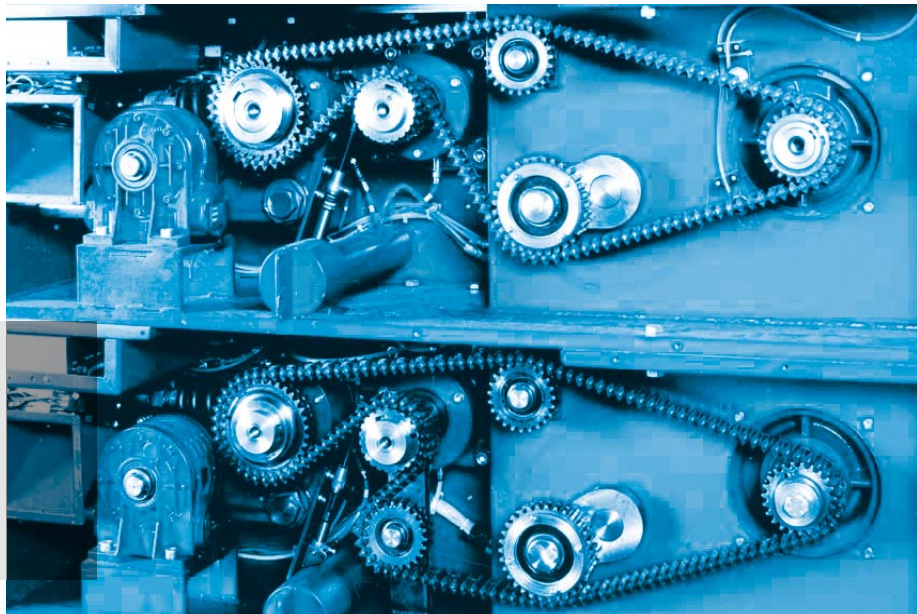

Bosch Rexroth AG
Tooth Chain Drives
Zur Dessel 14
31028 Gronau (Leine), Germany
P.O. Box 12 55
31022 Gronau (Leine), Germany
Phone +49 5182 5870
Fax +49 5182 58730
toothchain@boschrexroth.de
www.boschrexroth.de

Argentina

Bosch Rexroth S.A.I.C.,
Carapachay, Buenos Aires
Phone +54 1 147560140
Fax +54 1 147560136

Australia

Bosch Rexroth PTY. Ltd.
Kings Park N.S.W.
Phone +61 2 98317788
Fax +61 2 98315553

Austria

Bosch Rexroth GmbH, Pasching
Phone +43 7221 6051321
Fax +43 7221 6051226

Belgium

Bosch Rexroth N.V., Bruxelles
Phone +32 2 4512667
Fax +32 2 4512789

Brazil

Bosch Rexroth Ltda., Atibaia-SP
Phone +55 11 44145832
Fax +55 11 44145713

Canada

Bosch Rexroth Canada Corp. Ontario
Phone +1 9 05 3355511
Fax +1 9 05 3354184

Czech Republic

Bosch Rexroth spol.s.r.o., Brno
Phone +420 5 48126355
Fax +420 5 48126354

Denmark

Bosch Rexroth A/S, Hvidovre
Phone +45 36 774466
Fax +45 36 770866

Finland

Kraftmek Oy, Helsinki
Phone +35 8 97557355
Fax +35 8 97550414

France

Defa S.A., Argenteuil
Phone +33 1 30259420
Fax +33 1 30259459

Great Britain

Bosch Rexroth Limited, Cirencester
Phone +44 1285 863000
Fax +44 1285 863030

Greece

Bosch Rexroth S.A., Athens
Phone +30 210 3411600
Fax +30 210 3422759

Hungary

Bosch Rexroth Kft., Budapest
Phone +36 14223200
Fax +36 14223201

Italy

Bosch Rexroth S.p.A., Cernusco
Phone +39 02 923651
Fax +39 02 92365500

Vibi S.p.A., Settimo Milanese

Phone +39 02 33502335
Fax +39 02 33502377

Japan

Mecman Japan Ltd., Saitama-Shi
Phone +81 48 8333111
Fax +81 48 8333123

Malaysia

Bosch Rexroth Sdn. Bhd., Shah Alam
Selangor
Phone +60 378 448000
Fax +60 378 454800

The Netherlands

Bosch Rexroth B.V., Boxtel
Phone +31 411 651951
Fax +31 411 651483

New Zealand

Bosch Rexroth Ltd., Auckland
Phone +64 9 2744172
Fax +64 9 2746477

Poland

Bosch Rexroth Sp.z.o.o., Pruszkow
Phone +48 22 7381870
Fax +48 22 7588735

Portugal

MFE Comercio Int. Lda., Marinha
Grande Cedex
Phone +351 244 575840
Fax +351 244 575849

Singapore

Bosch Rexroth Pte. Ltd., Singapore
Phone +65 68 61 2702
Fax +65 68 61 1825

Slovakia

TBH Technik s.r.o., Zilina
Phone +421 41 5079711
Fax +421 41 5079726

Slovenia

La & Co. d.o.o., Maribor
Phone +386 24292660
Fax +386 24205550

South Africa

Tectra Automation (Pty) Ltd.,
Endenvale
Phone +27 11 9719400
Fax +27 11 9719440

South Korea

Bosch Rexroth Korea Ltd., Busan
Phone +82 51 2600768
Fax +82 51 2668131

Spain

Bosch Rexroth S.A.,
Sta. Perpetua de Mogoda
Phone +34 93 7479500
Fax +34 93 7479401

Sweden

Bosch Rexroth AB, Stockholm
Phone +46 8 7279551
Fax +46 8 6476373

Switzerland

Bosch Rexroth Schweiz AG, Buttikon
Phone +41 32 6863928
Fax +41 32 6863936

Turkey

Bosch Rexroth Otomasyon, Istanbul
Phone +90 212 4111300
Fax +90 212 4111317

USA

Bosch Rexroth Corp., Lexington/KY
Phone +1 8 59 2813434
Fax +1 8 59 2813487

The data specified above only serve to describe the product. No statements concerning a certain condition or suitability for a certain application can be derived from our information. The given information does not release the user from the obligation of own judgement and verification. It must be remembered that our products are subject to a natural process of wear and aging.

© This document, as well as the data, specifications and other informations set forth in it, are the exclusive property of Bosch Rexroth AG. Without their consent it may not be reproduced or given to third parties.

Subject to modification.
Printed in Germany.
Title image source:
Drauz Nothelfer GmbH
Order no.
8865000063/2007-11/EN