



NEW LAN SERIES RAILS  
THE COST-EFFECTIVE REVOLUTION IN LINEAR MOTION



COST-EFFECTIVE

MOVING YOUR IDEAS  
LINEAR AND TELESCOPIC MOTION TECHNOLOGY



# COST-EFFECTIVE REVOLUTION IN LINEAR MOTION

2

## NEW PATENTED T RACE-NOX THERMOCHEMICAL CASE HARDENING AND BLACK OXIDISING TREATMENT



### MAXIMUM COMPACTNESS

Compact C section rails in a range of sizes, with protected internal rollers.



### BLACK FINISH

Elegant, top quality, black finish obtained by coating-free thermochemical treatment. Flame and abrasion resistant. Does not flake off like zinc plating and other deposited treatments.



### OPTIMUM LUBRICATION

Extended, maintenance-free lifetime thanks to wipers with slow release felt lubricating pads that deposit a thin film of oil on the raceways.



### MAXIMUM STRENGTH

Fully nitrided and black oxidised rails for excellent wear resistance and effective protection against corrosion.



### SMOOTH SLIDING

Superbly smooth sliding, thanks to optimal preload adjustment of the eccentric rollers and good lubrication provided by the wipers with incorporated felt, impregnated with lubricant.



### SELF-ALIGNING SYSTEM

Can be used in conjunction with LUN U section rails to create a self-aligning two-slide motion system capable of compensating for installation alignment errors.



COST-EFFECTIVE PERFORMANCE AND DURABILITY

## TECHNICAL DESCRIPTION

LAN rails are made from sheet steel and shaped by high precision, ultra-smooth forming rollers. They are then case hardened using our revolutionary TRACE-NOX nitriding and black oxidising process to ensure an extended lifetime and excellent corrosion resistance.

The slider bodies are cathodically blackened for maximum corrosion resistance. The rollers are made from core tempered and precision ground, bearing grade steel. The ball bearings are lubricated for life with wide temperature range bearing grease and protected by Z2 rated metal shields.

Robust elastomer raceway wipers are fitted at both ends of the slider to protect the rollers and keep the raceways clean. The wipers incorporate oil-impregnated felt pads to keep the points of contact between raceway and roller properly lubricated, even for the lifetime of the rail. Wipers are held in place by a simple clip and can be removed and replaced easily.



## LAN AND LUN SERIES RAILS GUIDING AND FLOATING LINEAR MOTION SOLUTIONS

### CONFIGURATIONS

- **Sliders are available in 3 and 5-roller configurations.**  
In 3-roller versions, the two lateral rollers run on the same raceway while the central roller runs on the opposite raceway. The lateral rollers are fixed, concentric rollers, while the central roller has an eccentric pivot for preload adjustment.
- In 5-roller versions, the two lateral rollers and the central roller are fixed concentric rollers and run on the same raceway, while the second and fourth rollers run on the opposite raceway and have eccentric axles for preload adjustment.

### MAXIMUM LOAD CAPACITY

The asymmetric arrangement of the rollers means that the two sides of the slider have different load capacities. Sliders must therefore be oriented correctly on assembly. Maximum radial load capacity is achieved by orienting the slider so that radial load acts in the direction of the raceway contacted by the largest number of rollers. The side of the slider capable of supporting the greater load is identified by two relief dots.





## 3-ROLLER SLIDER

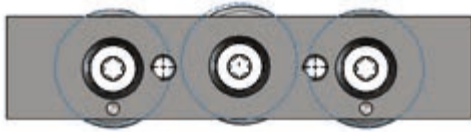

Dots on the slider body identify the side with the fixed rollers.

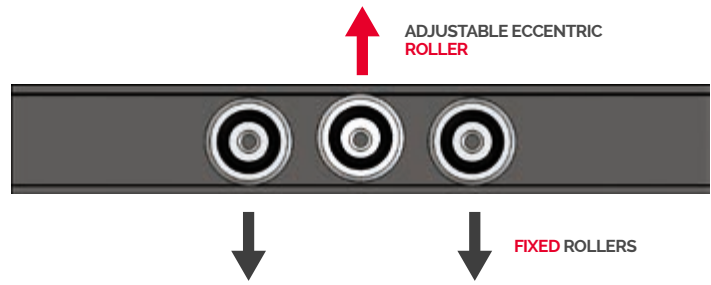

## ROLLER CONTACT POINTS



Dots on the slider body identify the side with the fixed rollers.

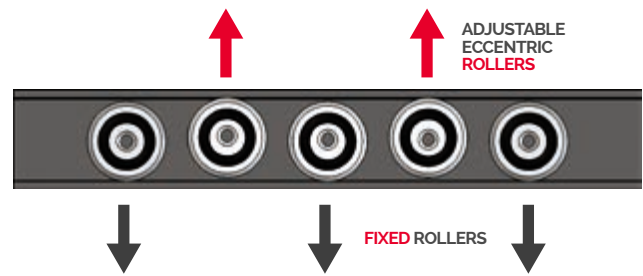

## ROLLER CONTACT POINTS

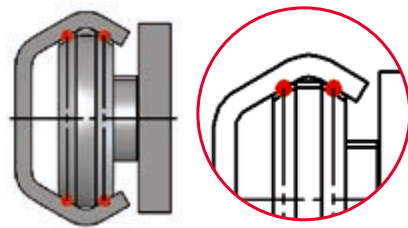

LAN GUIDING RAIL

The two bevelled surfaces of the roller run on the two slopes of the V-shaped raceway in the LAN rail to create 4 points of contact (two per roller). These guide linear motion both radially and axially.

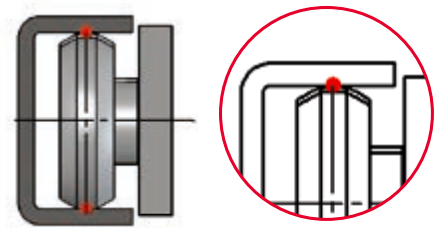

LUN FLOATING RAIL

The flat central surface of the roller runs on the flat raceway of the LUN rail to create 2 points of contact (one per roller). This guides linear motion radially but allows axial float.

## LAN SERIES GUIDING RAILS

## LUN SERIES FLOATING RAILS

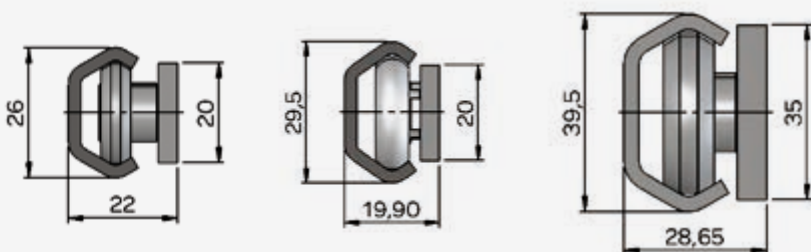

GUIDING RAIL  
LAN 26

LAN 30

LAN 40

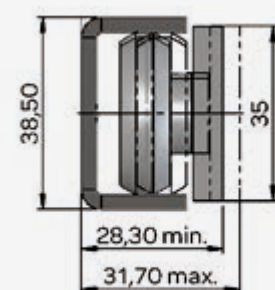

FLOATING RAIL  
LUN 40



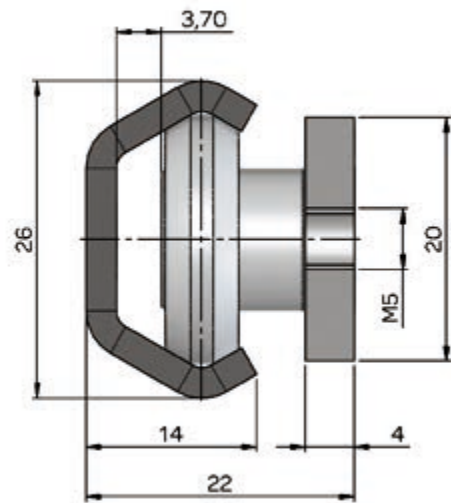
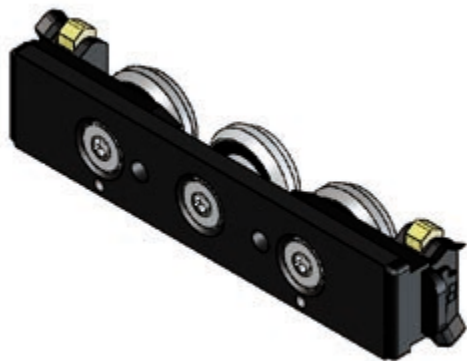

**SLIDERS** without wipers

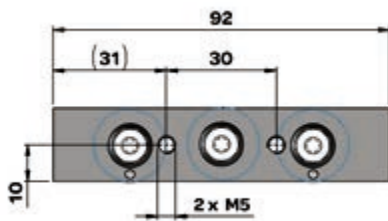

PAN26-3

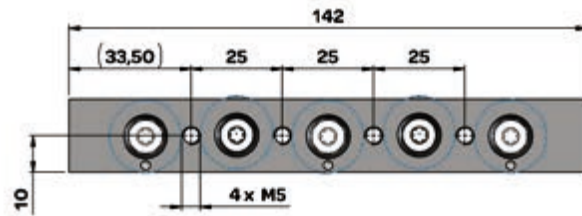

PAN26-5

**SLIDERS** with wipers

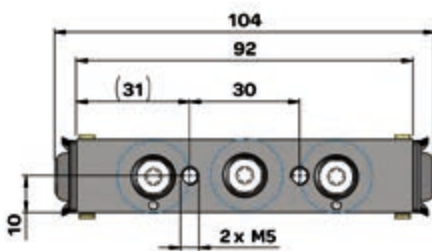

PAN26-3T

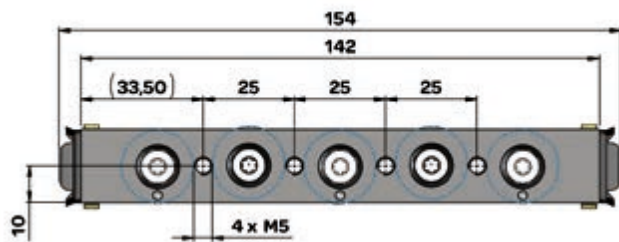

PAN26-5T

**DIRECTION** OF APPLIED LOADS

Rail code	Rail type	Weight (g)	Dynamic load factor C (N)	Load capacity				
				Co rad (N)	Co ax (N)	Mx (Nm)	My (Nm)	Mz (Nm)
PAN26-3	LAN26	100	1280	1120	380	3	9	16
PAN26-3T		110						
PAN26-5		140	1730	1520	540	5	15	45
PAN26-5T		150						

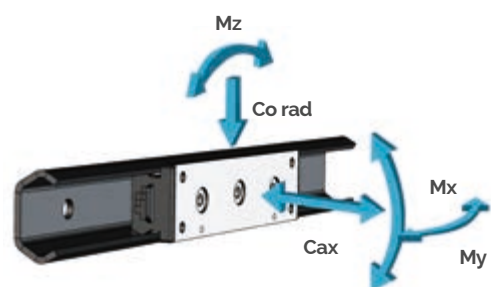

# PAN30 SERIES ROLLER SLIDERS FOR LAN30 RAILS

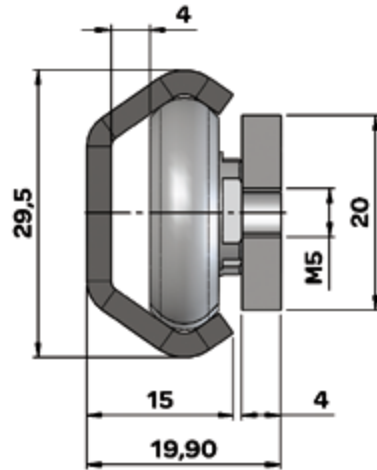
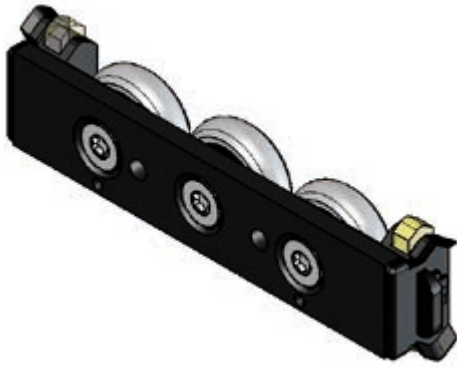

## SLIDERS without wipers

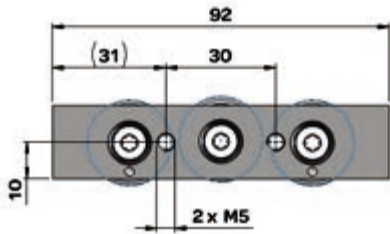

PAN30-3

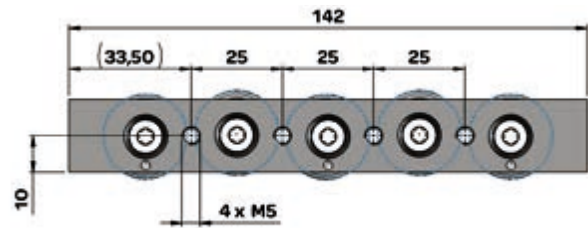

PAN30-5

## SLIDERS with wipers

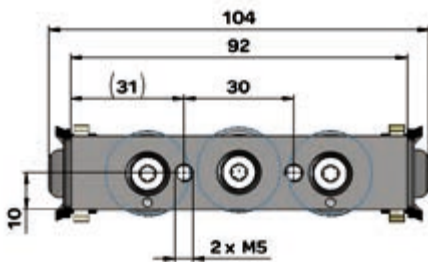

PAN30-3T

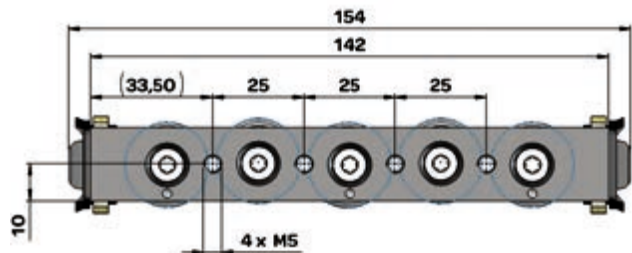

PAN30-5T

## DIRECTION OF APPLIED LOADS

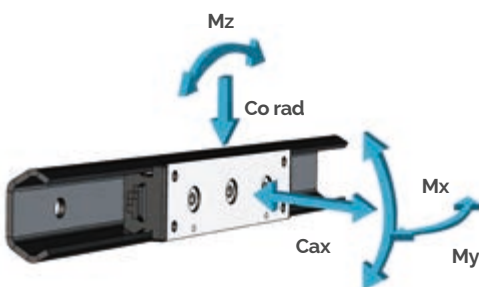

Rail code	Rail type	Weight (g)	Dynamic load factor (N)	Load capacity				
				Co rad (N)	Co ax (N)	Mx (Nm)	My (Nm)	Mz (Nm)
PAN30-3	LAN30	120	1360	1200	420	4	10	17
PAN30-3T		130						
PAN30-5		160	1830	1620	580	6	17	50
PAN30-5T		170						



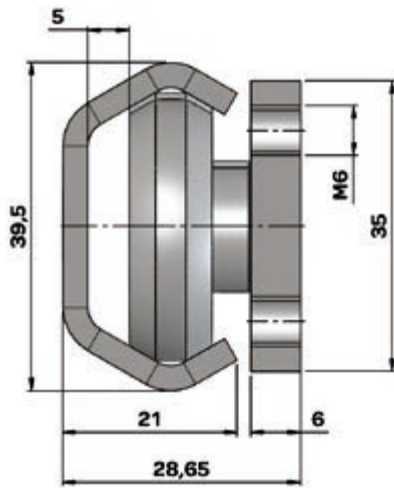
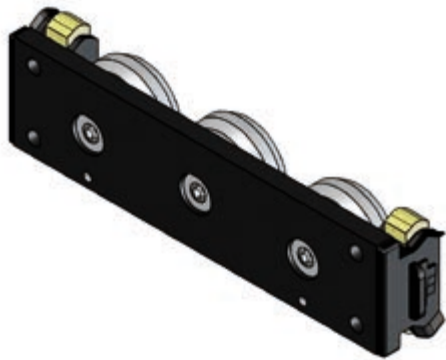

SLIDER WITH LAN40 RAIL

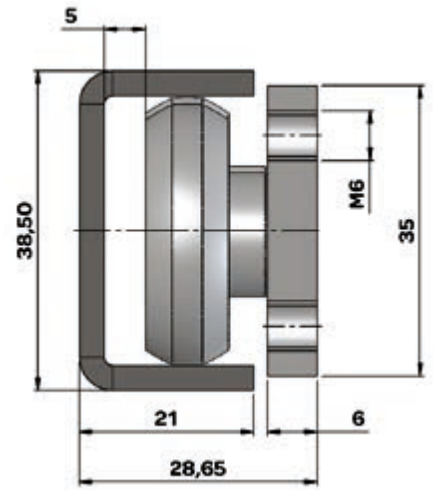

SLIDER WITH LUN40 RAIL  
SEE PAGE 10 FOR THE USE OF LUN RAILS.

PAN40 SERIES ROLLER SLIDERS FOR LAN40 AND LUN40 RAILS

SLIDERS without wipers

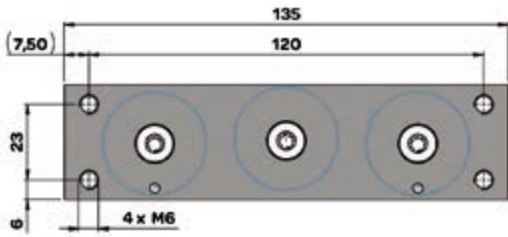

PAN40-3

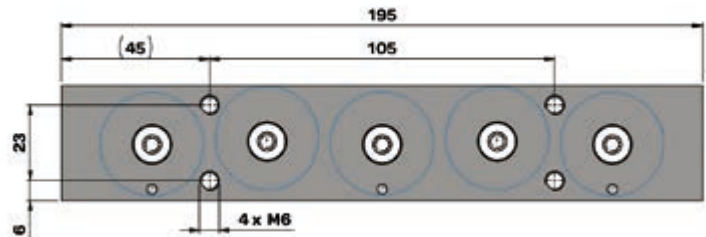

PAN40-5

SLIDERS with wipers

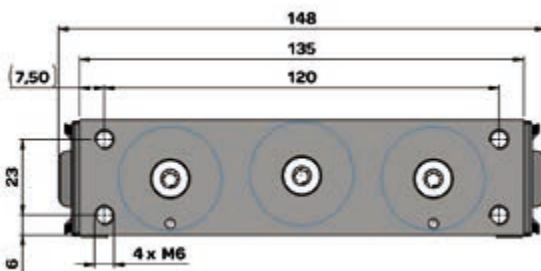

PAN40-3T

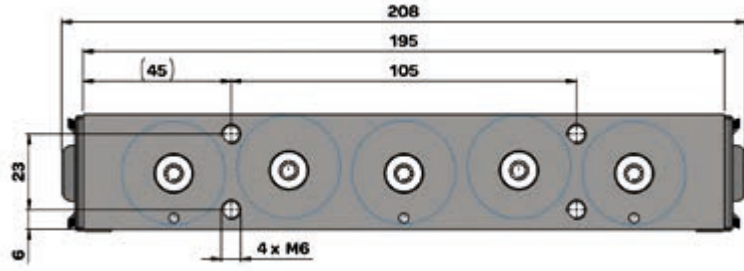

PAN40-5T

Performance with slider in LAN40 rail

Slider code	Rail type	Weight (g)	Dynamic load factor C (N)	Load capacity				
				Co rad (N)	Co ax (N)	Mx (Nm)	My (Nm)	Mz (Nm)
PAN40-3	LAN40	430	2720	2400	820	10	25	50
PAN40-3T		450						
PAN40-5		600	3670	3240	1150	18	42	125
PAN40-5T		620						

DIRECTION OF APPLIED LOADS

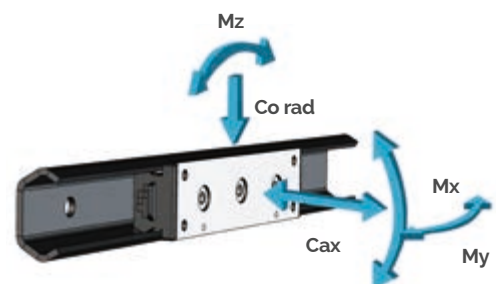

Performance with slider in LUN40 rail

Slider code	Rail type	Weight (g)	Dynamic load factor C (N)	Load capacity				
				Co rad (N)	Co ax (N)	Mx (Nm)	My (Nm)	Mz (Nm)
PAN40-3	LUN40	430	2720	1600	0	0	0	34
PAN40-3T		450						
PAN40-5		600	3670	2160	0	0	0	84
PAN40-5T		620						

# LAN40+LUN40 SELF-ALIGNING SYSTEMS

In two-slide linear motion systems, you can use one LAN40 rail with one LUN40 rail, with PAN40 sliders in both. This combination creates a self-aligning system capable of tolerating alignment errors of up to 3.4 mm.

The sliders in the LAN40 guiding rail are rigidly connected, via the mobile element, to the sliders in the LUN40 floating rail on the other side. The LAN40 guiding rail ensures play-free linear motion (see the description of points of contact on page 5). The sliders in the LUN40 floating rail are therefore also play-free but able to move axially across the flat raceways. This system avoids overload on the sliders as the result of rail alignment error.

The limit of axial movement of PAN40 sliders towards the inside of LUN40 rails is determined by the size of the heads of the rail fixing screws (see figures below). In particular, T RACE's special flat head 40.VC -SP01 screws permit approximately 1 mm of extra axial movement compared to standard ISO 7380 screws.

The limit of axial movement towards the outside of the LUN40 rail is determined by the point of departure of the roller from the raceway. The limit specified in the catalogue guarantees sufficient contact between rollers and raceway to support rated load.

Sliders in LUN40 rails offer less load capacity than the same sliders in LAN40 rails. (See the table on page 9).

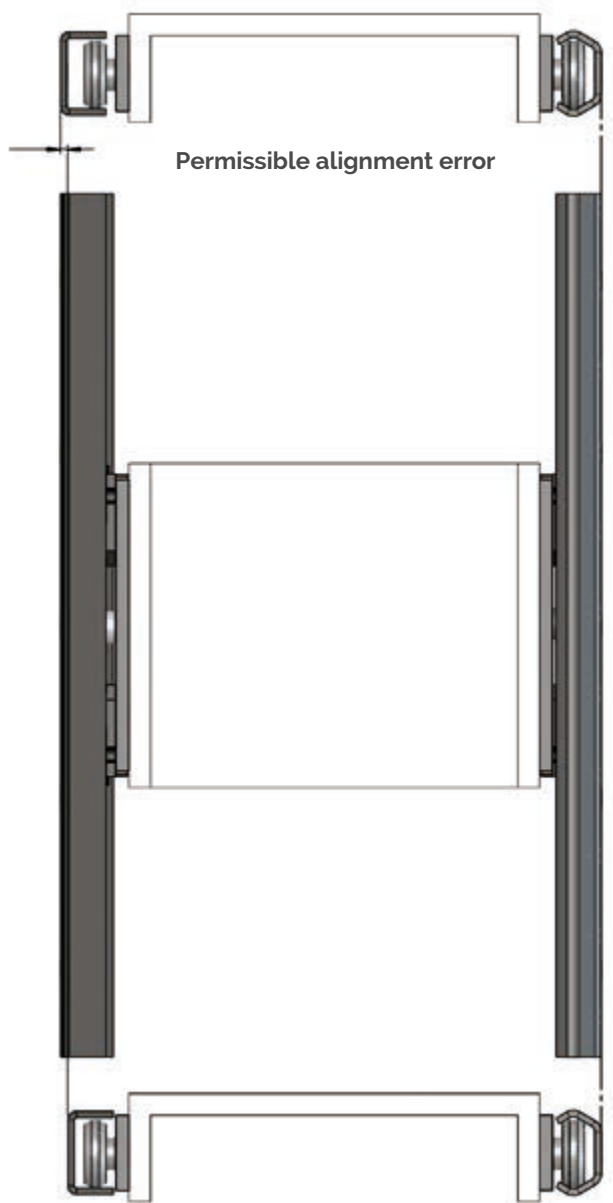
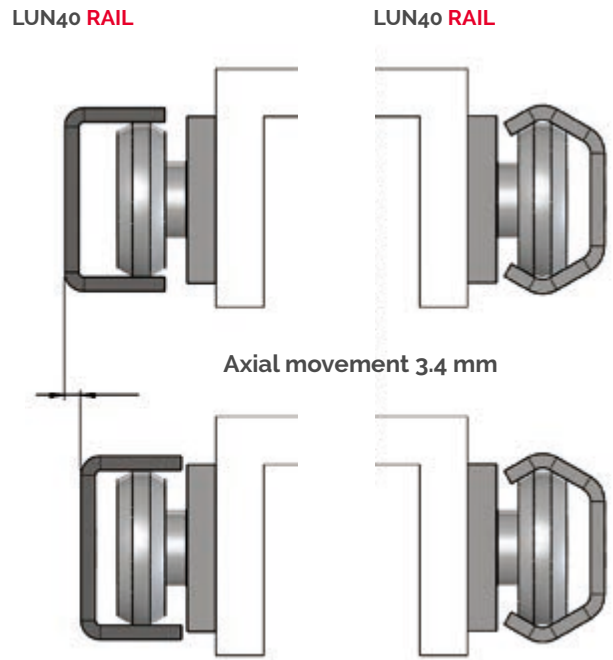

Min-max movement

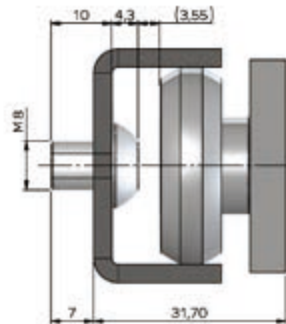

Limit towards outside of rail

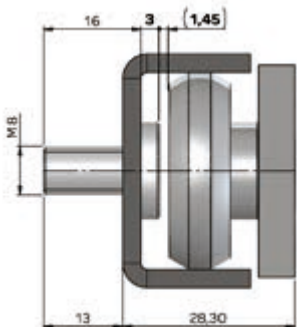

Limit towards inside of rail with special 40.VC-SP01 screws

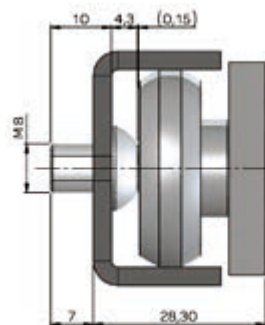

Limit towards inside of rail with ISO 7380 screws



As an alternative to our standard 3 and 5-roller sliders, rollers for use with LAN and LUN rails can also be mounted on custom sliders or directly on the mobile element. In such cases, the number, arrangement and types of roller need to be chosen to match the requirements of the application. See page 13 for assembly and adjustment instructions.

All our rollers are made from core tempered and precision ground bearing grade carbon steel. Rollers are of the single row ball-bearing type, with the balls held in place by a metal cage. Precision ground surfaces ensure a smooth, silent rolling action.

Rollers are also fitted with 2Z rated metal shields to protect the ball bearings raceway and ensure good resistance to high temperatures. The ball bearing is lubricated for life with a wide temperature ranging lithium soap grease.

The mounting axle is made in one piece with the inner bearing, for maximum strength. Rollers come in two types: eccentric and concentric.

PEN and PCN series rollers for size 26 and 40 rails have a hexagonal recess for an Allen key in the side opposite the threaded fixing hole. This serves to hold the axle steady while the fixing screw is being tightened with a second Allen key. On eccentric rollers, it also serves to adjust roller position, so as to reach the desired preload setting.

PEV and PCV rollers for size 30 rails have a special central square pivot accessible with a flat key, inserted between slider body and eccentric rollers. The flat key is supplied by TRACE. See page 12 for further instructions about Slider preload setting.

**PEN26**

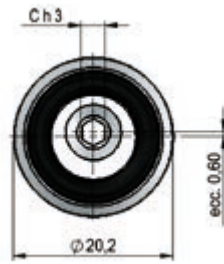

**PCN26**

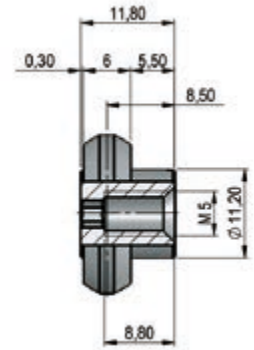

**PEV30**

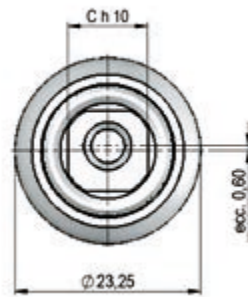

**PCV30**

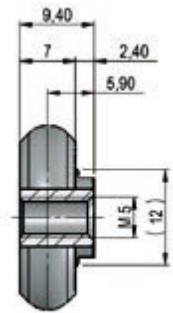

**PEN40**

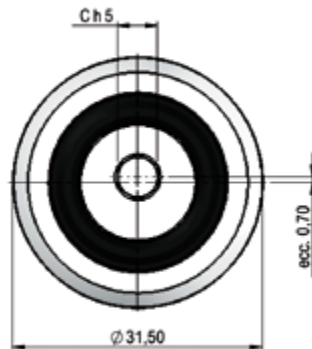

**PCN40**

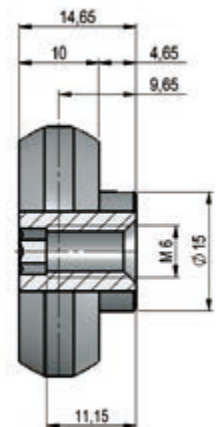
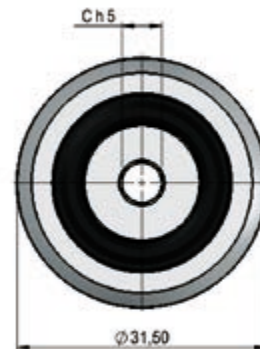

Roller code	Type	Rail type	Dynamic load factor C (N)	Load capacity *		Weight (g)
				Co rad (N)	Co ax (N)	
PCN26	concentric	LAN26	640	560	126	10
PEN26	eccentric					
PCV30	concentric	LAN30	680	600	140	20
PEV30	eccentric					
PCN40	concentric	LAN40	1360	1200	410	40
PEN40	eccentric					
PCN40	concentric	LUN40	910	800	0	40
PEN40	eccentric					

# PRELOAD SETTING OF SLIDERS

If you order sliders pre-assembled in their rails, all adjustments are made in our factory using special tools to guarantee accurate roller alignment and a slight preload, P1, to eliminate play and ensure the smoothest possible movement.

Slider preload is adjusted by means of one eccentric roller in the case of 3-roller sliders or two eccentric rollers in the case of 5-roller sliders (see page 5). The eccentric rollers must be adjusted so that they run along the raceway opposite that on which the fixed, load-bearing rollers run. The adjustment procedure is given below.

Only adjust the eccentric rollers. Use an Allen key to engage the hexagonal recess in the roller axle (or the special flat key for PAN30 sliders) and complete the adjustment in the following steps:

1 - Remove the wipers from the ends of the slider to feel the play more easily. Tighten the eccentric roller's fixing screw until the lock washer makes firm contact but does not stop the axle turning. It must be possible to turn the eccentric axle with the Allen key smoothly while maintaining firm contact between the axle and the slider.

2 - Looking from the roller side of the slider, turn the axle clockwise until the eccentric roller lines up approximately with the fixed rollers, or is only a little bit off the fixed roller raceway. Do not adjust the roller to the apex of the eccentric.

3 - Grip the rail in a vice or some other rigid support so that you do not need to hold it with your hands. Insert the carriage in the rail and engage an Allen key in the axle of the eccentric roller, through one of the holes in the rail. Looking at the slider from the screw side, turn the axle anti-clockwise until the eccentric roller rests on the raceway opposite that of the fixed rollers. As you turn the eccentric axle, turn the fixing screw in the same direction with the other Allen key to prevent it becoming looser or tighter. Use both hands.

4 - Check that there is no play in the slider by pressing alternately on both ends of the slider. Repeat this check at various points along the rail. There must be no play at any position.

5 - Hold the eccentric steady with one key and tighten the fixing screw with the other.

**IMPORTANT!**

Do not use the eccentric to loosen or tighten the roller. Use the fixing screw!

6 - You can estimate the amount of preload applied by slowly removing and re-inserting the slider from one end of the rail. Insertion force  $F_i$  is proportional to preload. Generally speaking, correct preload is indicated by an insertion force within the range given in the table.

7 - Use a torque wrench to tighten the roller fixing screw to the tightening torque  $M_t$  given in the table. Take care to hold the eccentric in position with the Allen key. On 5-roller sliders, the above adjustment procedure must be repeated for each eccentric roller. When adjusting the second eccentric roller, make sure that the roller has contacted the correct raceway by checking its direction of rotation. It must rotate in the opposite direction to the fixed rollers alongside it. The direction of roller rotation can be seen from the back of the rail through one of the mounting holes. To ensure that preload is distributed evenly between the two eccentric rollers, remove the slider from the rail and check that insertion force is identical with the slider rotated through 180 degrees.

The adjustment procedure is identical for PAN30 series sliders, with the sole exception that instead of using an Allen key to engage the axle through a hole in the rail, a special key is needed to pass between the slider body and the rail and engage flats on the axle. With sliders of this type, you can even adjust preload with the rail mounted on the structure. It is nevertheless preferable to adjust preload on the bench following the procedure given above.

**IMPORTANT!**

Where required, clip the wipers back in before engaging the slider in the rail. Take care to orient the slider in the direction of applied load.

**STEP 1-2**

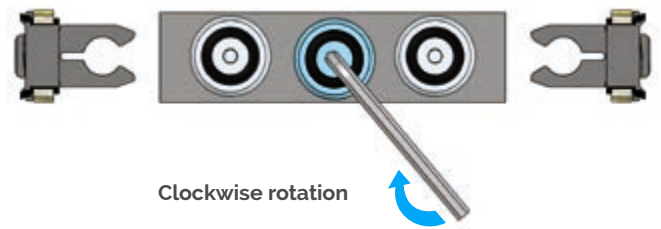

**STEP 3**

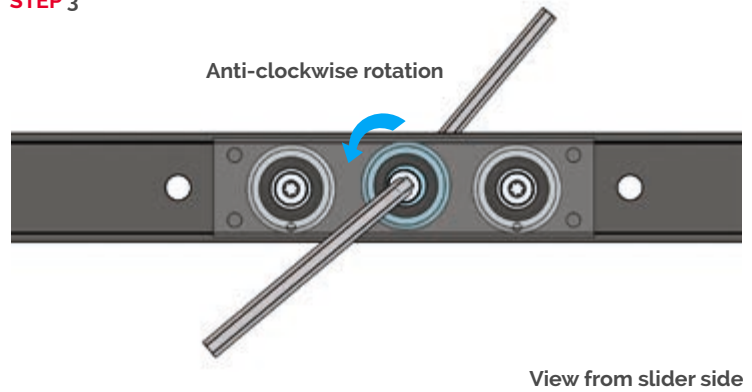

**ADJUSTING PAN26 AND PAN40 sliders**

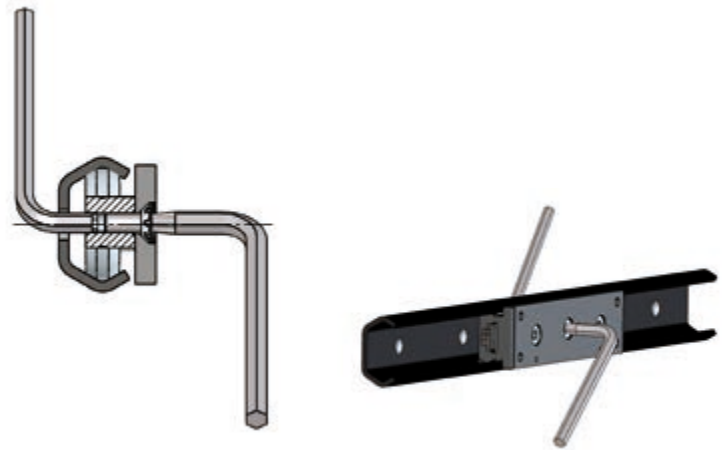

**ADJUSTING PAN30 sliders**



Slider type	$M_t$ - Tightening torque
PAN26	7 Nm
PAN30	7 Nm
PAN40	12 Nm

Slider type	$F_i$ - Insertion force	
	min	max
PAN26	1	5
PAN30	1	5
PAN40	1	6



In addition to standard sliders, rollers can also be fitted to custom sliders or even directly to mobile elements. When doing so, the following points must be kept in mind:

The minimum number of rollers is 3. Of these, 2 must be concentric rollers and located to run in the raceway of the rail that supports the main load. The third must be an eccentric roller, adjusted to run along the opposite raceway. If more than two rollers are needed to support the main load, only two must be fixed, concentric rollers. Additional load-bearing rollers must be eccentric rollers adjusted to run on the same raceway. It is important to ensure that eccentric rollers used in this way are perfectly aligned in order to distribute load equally.

At least one eccentric roller must be provided and adjusted to run on the opposite raceway in order to eliminate play. Additional rollers may be needed, on the basis of the direction of load. e.g. to counteract bi-directional or overhung loads.

Eccentric rollers used in this way must be located as near as possible to a concentric roller. See the table alongside for minimum distances.

The arrangement and number of rollers must always be determined by the amount and direction of load applied by the element the rollers support. The overall load capacity of the assembly is limited by the maximum load capacity of the most highly loaded roller. The roller bearing that takes the greatest load should always be a concentric roller.

T-RACE's Technical Assistance Service is always happy to suggest the best arrangement of rollers for specific applications.

If load is supported by more than two rollers (e.g. 3, 4 or 5) on the same raceway, and load is located centrally with respect to the set of rollers, total load capacity is determined by the load capacity of one roller multiplied by the total number of rollers, reduced by a suitable safety factor depending on the accuracy of alignment of the rollers and on the rigidity of the surface to which they are fixed. Holes in the mobile element intended to fix rollers in place must be of the bare minimum diameter necessary for the fixing screw to pass through and must be of the minimum length specified in the table.

Fixing screws for eccentric rollers must always be fitted with a lock washer to permit adjustment of preload. The procedure for adjusting eccentric rollers is similar to that given on page 12 for standard sliders, as are screw tightening torques.

## STEP 1-2

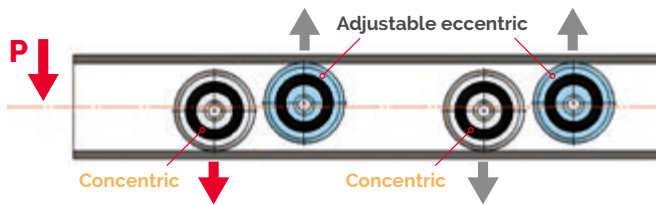
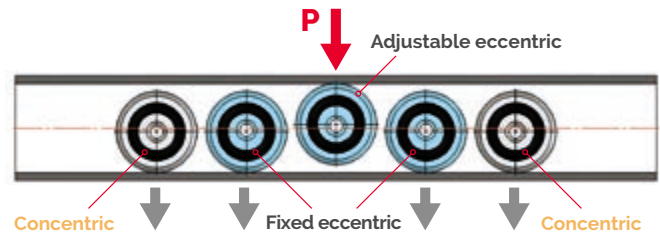
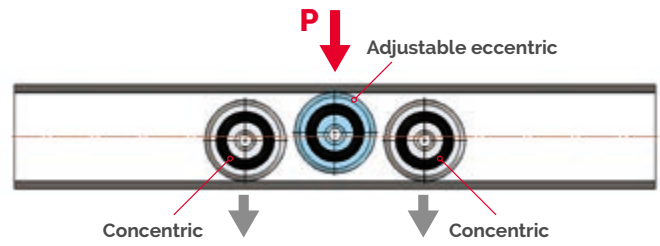

## Position of rollers

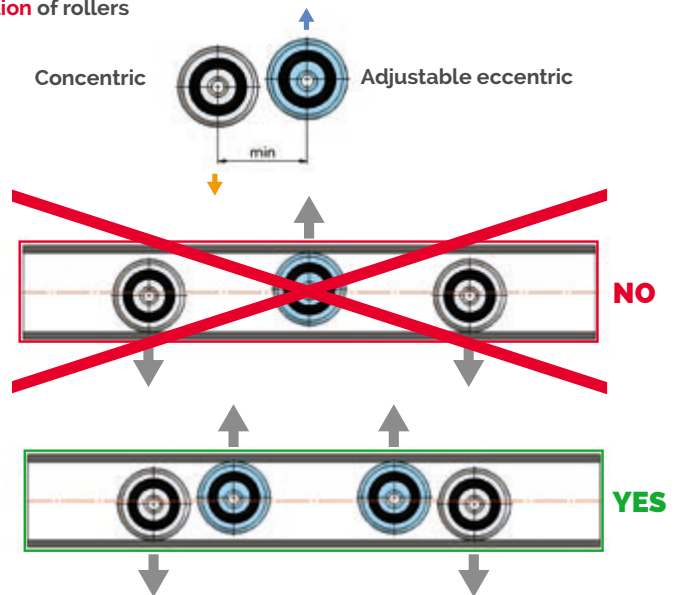

## Drilling of roller supports

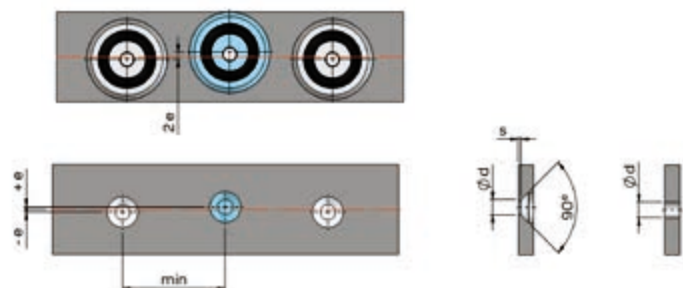

Roller type	Minimum recommended centre to centre distance (mm)	Diameter of fixing screw hole $d$ (mm)	Length of hole $s$ min. (mm)	Hole alignment error $e$ (mm)
PCN26	22	5 +0,1/0	1	0,2
PEN26				
PCV30	25	5 +0,1/0	1	0,2
PEV30				
PCN40	34	6 +0,1/0	1,5	0,4
PEN40				

# LUBRICATION AND USE OF WIPERS

Standard sliders come in two versions, with wipers (e.g. PAN26-3T) and without wipers (e.g. PAN26-3).

Wipers are made from a thermoplastic elastomer and have robust, low friction, blades that maintain contact with the raceways to remove dust and dirt and provide a clean contact surface for the rollers. The wipers also incorporate oil-impregnated felt pads that slide along the raceways. These provide additional cleaning and apply a thin film of lubricant to ensure extended rail life.

Wipers clip over the axles of the end rollers and can be removed easily. In most applications, wipers provide sufficient lubrication for the entire lifetime of the rail. In certain applications in critical (e.g. dusty or dirty) environments, it may prove necessary to replace them at intervals.

Sliders with wipers guarantee correct raceway lubrication and ensure an extended lifetime for the rail. They are recommended for applications involving frequent or continuous motion.

Sliders without wipers are adequate for applications involving less frequent movements and are also better suited to high temperature applications that are incompatible with plastic parts.

Wipers can be purchased and fitted at a later date to sliders originally supplied without wipers.

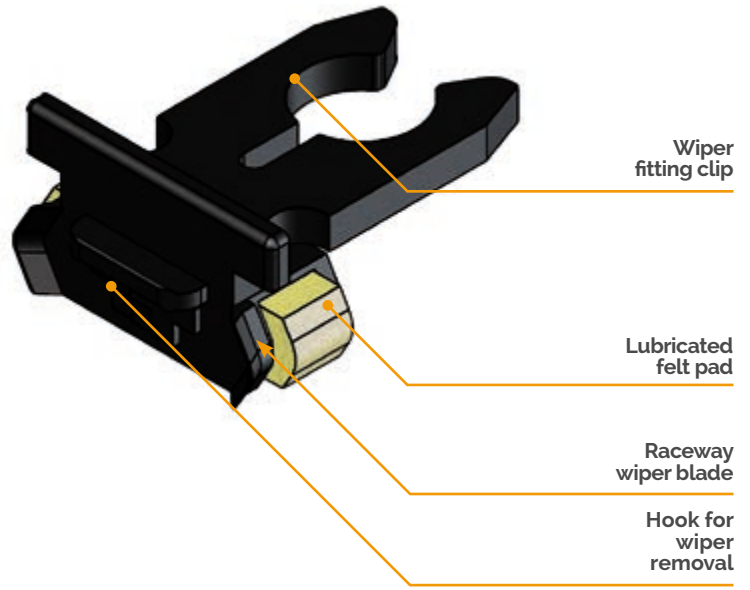

Wiper code	For slider type
KT-LA26	PAN26-3 / PAN26-5
KT-LA30	PAN30-3 / PAN30-5
KT-LA40	PAN40-3 / PAN40-5

## CHOOSING THE RIGHT SIZE

Once you have chosen the best rail and slider configuration, you need to choose the right size for the static loads and lifetimes involved.

To calculate static load, you need to determine the load applied to each slider. Once you have identified the slider subject to the most load, choose a suitable safety factor on the basis of maximum permissible static load.

If applied load is the result of a combination of radial and axial loads and moments, you will have to determine the value of each component load and verify that:

$$\frac{P_{ax}}{Co_{ax}} + \frac{P_{rad}}{Co_{rad}} + \frac{M_{ex}}{M_x} + \frac{M_{ey}}{M_y} + \frac{M_{ez}}{M_z} \leq \frac{1}{Z}$$

### DIRECTION OF APPLIED LOADS

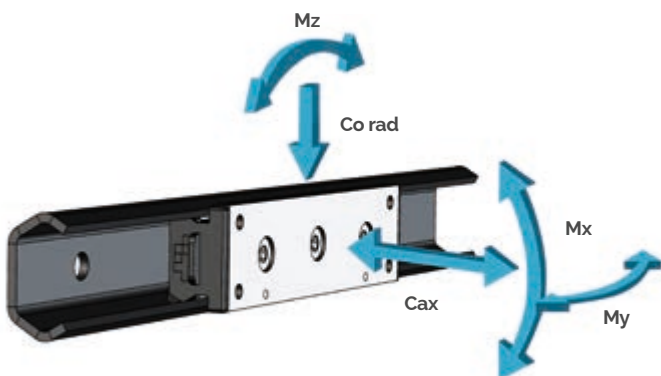

<b>Pax</b>	= axial component of applied load
<b>Prad</b>	= radial component of applied load
<b>Mex, Mey, Mez</b>	= applied moments
<b>Coax</b>	= axial load capacity
<b>Co rad</b>	= radial load capacity
<b>Mx, My, Mz</b>	= moment resistance capacity
<b>Z</b>	= safety factor > 1

Radial load capacity **Co rad** is measured only in the direction of the dots marked on the slider.

### RECOMMENDED VALUES:

Z	Operating conditions
1-1,5	Accurately determined static and dynamic loads. Precision installation, rigid structures.
1,5-2	Average conditions.
2-3,5	Inaccurate determined applied loads. Vibration, non-rigid structures. Approximate installation, unfavourable ambient conditions.



The theoretical lifetime of rollers and rails can be calculated using the following conventional formula, expressed in km or travel. Bear in mind, however, that the value obtained in this way is purely indicative and must be used with caution. Actual component lifetimes under real operating conditions may differ significantly from calculated figures, since wear and fatigue depend on factors that cannot be accurately predicted, e.g.:

- Inaccurate initial estimates of effective load conditions
- Overloads caused by inaccurate assembly
- Vibration, pulsed dynamic stress and impacts
- Insufficient lubrication of raceways
- Wide differential changes in temperature
- Dusty or dirty environments
- Assembly errors
- Long travel and frequent movement

$$L (Km) = 100 \cdot \left( \frac{P}{C} \right)^3 \cdot \frac{fc}{n} \cdot fa$$

## PER SLIDER

$$P = Prad + \left( \frac{P_{ax}}{Co_{ax}} + \frac{M_{ex}}{M_x} + \frac{M_{ey}}{M_y} + \frac{M_{ez}}{M_z} \right) \cdot Corad$$

**C** = dynamic load factor of slider

**P** = equivalent load applied to the slider

**fc**

factor depending on stroke length, taking into account the fact that short strokes cause increased frequency of roller passage over the same section of raceway for the same total travel. Assign a value of 1 for strokes over 2 m; for strokes of less than 2 m, derive the value from the graph below.

**n** = number of sliders

**fa**

factor depends on lubrication and ambient factors; see table for recommended values

## FACTOR fc

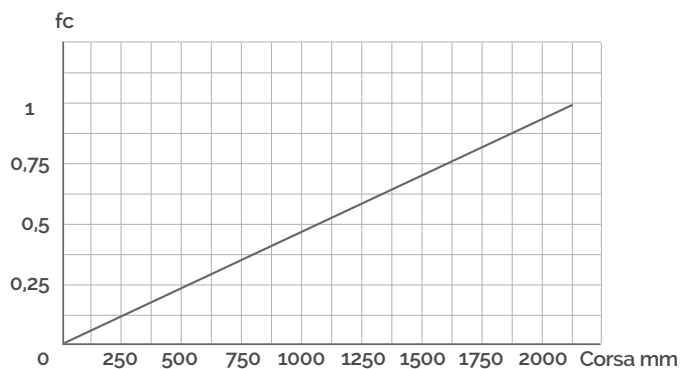

Safety factors  $fc$  and  $fa$  applied to the result of the theoretical formula are only intended as guidelines for the system designer in assessing the effect of operating conditions on real lifetime. They must not be understood as accurate indications. For further information, contact T-RACE's Technical Assistance Service.

fa	Operating conditions
0,7-1	Presence of wipers with lifelong lubrication pads, environment free from dust and dirt, accurate installation.
0,2-0,5	No wipers, environment with average dust and dirt, average temperature excursions and vibration.
0,05-0,1	No wipers, poor lubrication, environment with high levels of dust and dirt, wide temperature excursions and strong vibration.



**T RACE S.p.A.**  
Via per Cascina Restelli, 6  
20886 Aicurzio (MB)  
ITALY

Tel: (+39) 039 6817201  
Fax: (+39) 039 6817217

[info@t-race.com](mailto:info@t-race.com)  
[www.t-race.com](http://www.t-race.com)

**T RACE GmbH**  
Heide 33  
51399 Burscheid  
GERMANY

Phone: (+49) 02174 49 93 88-0  
Fax: (+49) 02174 49 93 888

[post@t-race.de](mailto:post@t-race.de)  
[www.t-race.de](http://www.t-race.de)