

The Linear System



MayTec GmbH plant in Dachau



Small parts store



Stock of aluminium profiles

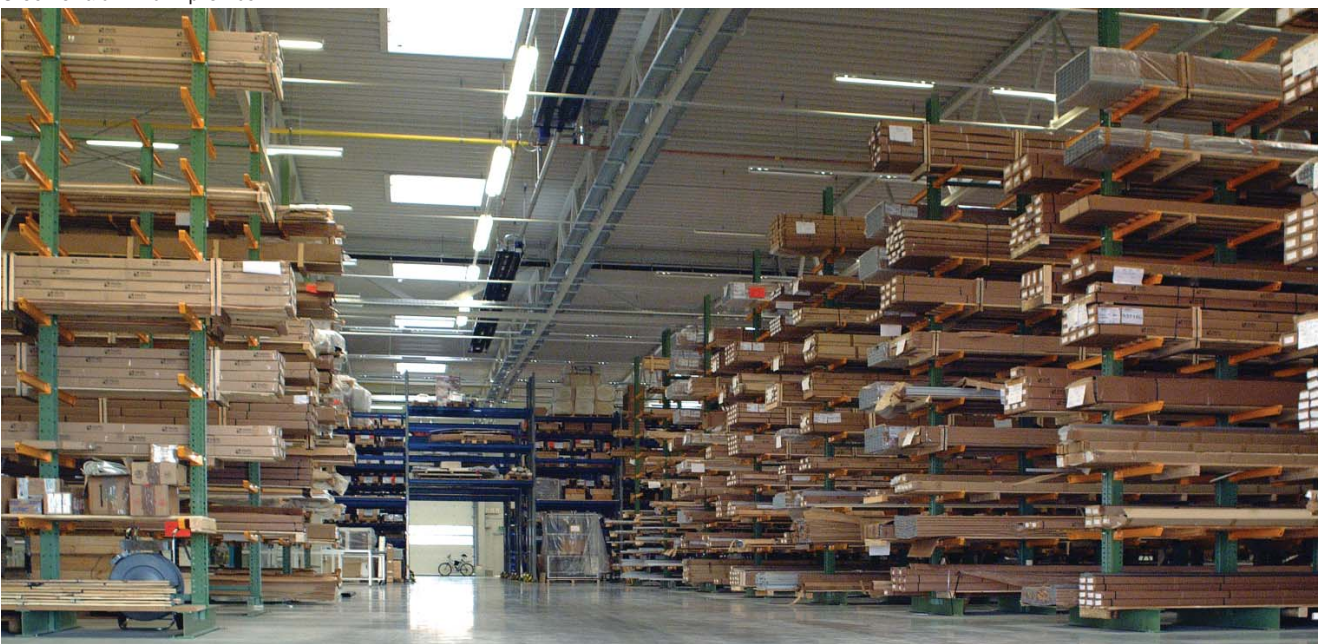

Linear units complete 4.101

Linear shaft guidance complete 4.119

Catalogue in preparation:

Carriage unit 4.121

Drive unit 4.131

Turning unit without shaft end 4.141

Turning unit with shaft end 4.151

Motor flange 4.161

Synchronising unit 4.171

Gearbox unit 4.181

Table of contents

Article number group	Page
4.100	The MayTec Linear System 2
4.100	Numerical key for articles 3
4.101	Linear units complete, with toothed belt drive 4
4.101	with wheel guide 4
4.101	with ball bearing guide 6
4.101	Design of the linear system 8
4.101	Selection table for linear units 10
4.101	Shaft guidance horizontal 10
4.101	Shaft guidance vertical 16
4.119	Linear shaft guidance complete 18
4.119	Construction form 18
4.119	Numerical key for articles 19
4.119	Linear shaft guidance, single sided 20
4.119	Linear shaft guidance, double sided 29
4.119	Shaft guidance profiles 36
4.119	for shaft-Ø12 36
4.119	for shaft-Ø16 37
4.119	for shaft-Ø20 38
4.119	for shaft-Ø25 39
4.119	Shafts 40
4.119	with radial thread 41
4.119	Machining of shafts 42
4.119	Order example 43
4.A	Application samples 44

Solutions with Innovative Profile

The Linear System

The MayTec linear guidance system offers the seamless integration of components from all well known bearing manufacturers onto the MayTec profile system.

Along with the integration of these components, MayTec also offers a huge range of accessories to expand and simplify the integration of linear guidance technology with profile technology.

The integration of various linear guidance hardware is also possible due to the modular concept of the system.

Economical and functional solutions can now be realised with a minimum of time and effort.

Performance

Due to the modularity of the MayTec linear system and profiles, you can choose any of the following:

- Delivery of the individual components ex factory
- Delivery of cut and prepared profiles, shafts and components according to parts list for customer's assembly
- Delivery of pre-fitted modular units
- Delivery of complete systems
- Assembly on site

Application

Due to the flexible and modular design, the MayTec profile system is extremely easy to use and fast to assemble. The system is also very easy to modify if necessary and components can be reused at any time.

An expert team is ready to support you with the use of the MayTec profile system and with your specific project requirements. Your chosen configuration depends only on the dimensions, expected forces and the required stability.

Encased Roller Bearings

A tried and tested linear guidance system with a huge variety of application possibilities.

Depending on the required specifications and accuracy, encased roller bearings can be used for low or high load applications.

- Suitable for rough or dirty applications
- High force tolerance with low wear
- High accuracy with low friction
- Long life expectancy



Shaft Guidance

A proven and extremely flexible guidance system due to the compact nature of the construction.

Depending on the application requirements, either sliding or ball bearing guides can be used.

Shaft guide systems are used where high accuracy along with carriage stability is required.

- Compact form
- Low resistance
- High stability
- High accuracy
- Quiet rolling noise level



Challenge us !

Linear unit complete

4.1□□.□□□□□□.□□□□□□.
 4.1□□.□□□□□□.□□□□□□.
 4.1□□.□□□□□□.□□□□□□.
 4.1□□.□□□□□□.□□□□□□.
 4.1□□.□□□□□□.□□□□□□

Key (line 1)
 Subassembly ¹⁾
 Drive ²⁾
 Profile • size
 • orientation ³⁾
 Shaft • orientation ⁴⁾

□□.□□.□□□□□□□□□□
 □□.□□.□□□□□□□□□□
 □□.□□.□□□□□□□□□□
 □□.□□.□□□□□□□□□□
 □□.□□.□□□□□□□□□□
 □□.□□.□□□□□□□□□□
 □□.□□.□□□□□□□□□□
 □□.□□.□□□□□□□□□□
 □□.□□.□□□□□□□□□□
 □□.□□.□□□□□□□□□□
 □□.□□.□□□□□□□□□□
 □□.□□.□□□□□□□□□□
 □□.□□.□□□□□□□□□□
 □□.□□.□□□□□□□□□□
 □□.□□.□□□□□□□□□□
 □□.□□.□□□□□□□□□□

Key (line 2)
 Shaft • number ⁵⁾
 • assembly ⁶⁾
 • Ø
 Carriage • material ⁷⁾
 • base plate ⁸⁾
 • bearing - roller ⁹⁾
 - bush ¹⁰⁾
 Belt • type ¹¹⁾
 • material ¹²⁾
 • width
 Turning unit • motor ¹³⁾
 • shaft end - left ¹⁴⁾
 - right ¹⁴⁾

- | | | |
|---|--|--|
| <p>¹⁾ 0 = linear unit complete
 1 = linear guidance
 2 = carriage unit
 3 = drive unit
 4 = turning unit without shaft end
 5 = turning unit with shaft end
 6 = motor flange
 7 = synchronising unit
 8 = gearbox unit</p> <p>²⁾ 0 = without drive
 1 = toothed belt
 2 = chain
 3 = threaded spindle
 4 = toothed rack
 9 = multiple</p> <p>³⁾ H = horizontal
 N = neutral
 V = vertical</p> | <p>⁴⁾ H = horizontal
 V = vertical</p> <p>⁵⁾ 1 = single sided
 2 = double sided</p> <p>⁶⁾ 2 = with guide profile</p> <p>⁷⁾ shaft mounting elements
 1 = coated steel steel, galvanised
 2 = X46Cr13 steel, galvanised
 3 = X46Cr13 VA</p> <p>⁸⁾ 1 = alu plate
 2 = profile
 3 = profile frame</p> <p>⁹⁾ 11 = 2×fixed / 2×eccentric, adjustable topside
 12 = 2×fixed / 2×eccentric, adjustable underside
 15 = 4×eccentric, adjustable topside
 16 = 4×eccentric, adjustable underside</p> | <p>¹⁰⁾ 21 = ball
 25 = slide; synthetic
 28 = slide; ceramics</p> <p>¹¹⁾ A = HTD5M
 B = HTD8M</p> <p>¹²⁾ G = fiber glass
 S = steel</p> <p>¹³⁾ 1 = for motor with hollow shaft
 2 = for motor with shaft
 3 = for motor with base</p> <p>¹⁴⁾ 0 = without
 1 = left
 2 = right
 3 = double sided</p> |
|---|--|--|

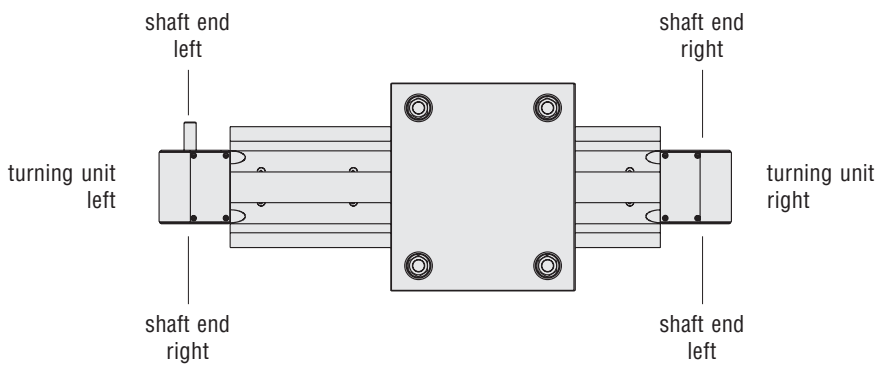

additional required order information:
 • lift
 • carriage length

Linear unit

- with toothed belt drive
- with wheel guide

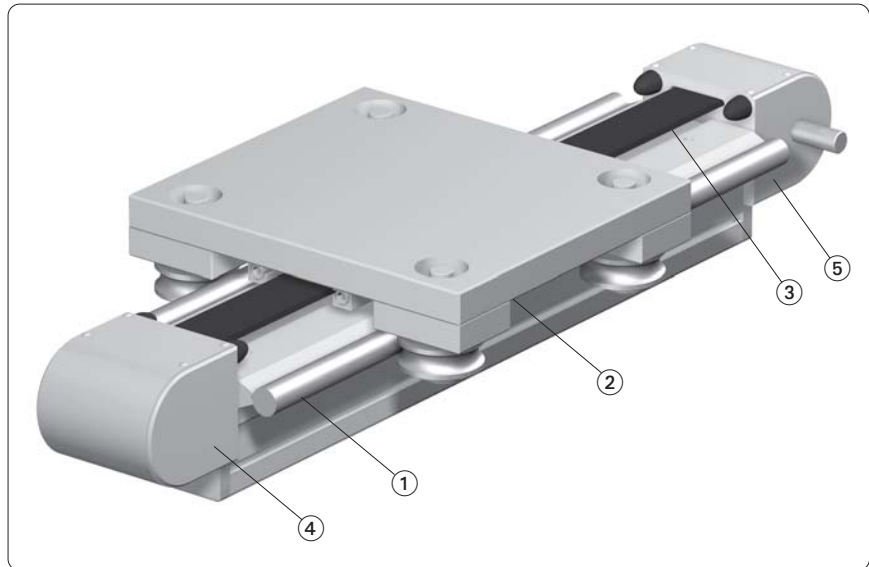
Component groups of linear units
Ordering description:

Article-No.	Description	
4.101...	Linear unit complete including:	
① 4.119...	Linear shaft guidance	
② 4.121...	Carriage unit	<i>(catalogue in preparation)</i>
③ 4.131...	Drive unit	<i>(catalogue in preparation)</i>
④ 4.141...	Turning unit without shaft end	<i>(catalogue in preparation)</i>
⑤ 4.151...	Turning unit with shaft end	<i>(catalogue in preparation)</i>
⑥ 4.161...	Motor flange	<i>(catalogue in preparation)</i>
⑦ 4.171...	Synchronising unit	<i>(catalogue in preparation)</i>
⑧ 4.181...	Gearbox unit	<i>(catalogue in preparation)</i>

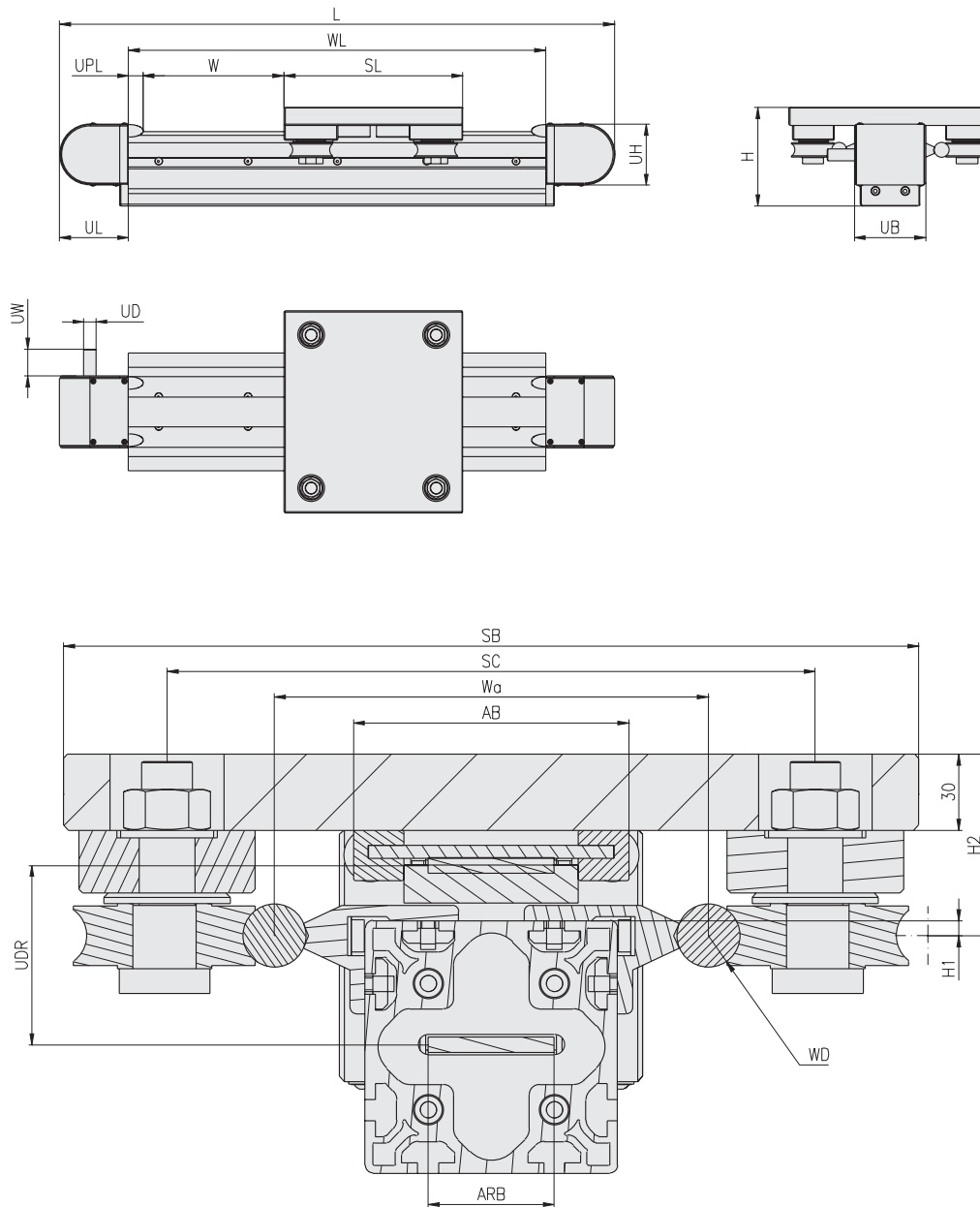

- AB = width of drive unit
- ARB = belt width of drive unit
- H = total height
- H1 = height from shaft center to upper edge of profile
- H2 = height from shaft center to upper edge of carriage
- L = total length
- SB = width of carriage
- SC = center distance from ball bearing to carriage
- UB = width of turning unit
- UD = shaft end diameter of turning unit
- UDR = pinion diameter of turning unit
- UH = height of turning unit
- UL = length of turning unit
- UPL = parabolic spring length of turning unit
- UW = shaft end length of turning unit
- W = lift
- Wa = axle distance of shaft guidance
- WD = diameter of shaft guidance
- WL = profile length of shaft guidance

Linear unit

- with toothed belt drive
- with ball bearing guide

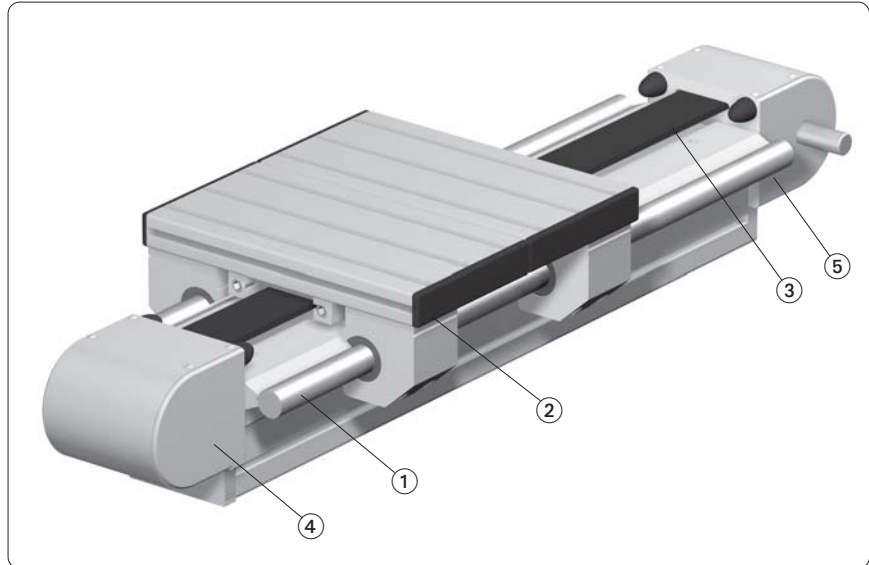
Component groups of linear units
Ordering description:

Article-No.	Description	
4.101...	Linear unit complete including:	
① 4.119...	Linear shaft guidance	
② 4.121...	Carriage unit	<i>(catalogue in preparation)</i>
③ 4.131...	Drive unit	<i>(catalogue in preparation)</i>
④ 4.141...	Turning unit without shaft end	<i>(catalogue in preparation)</i>
⑤ 4.151...	Turning unit with shaft end	<i>(catalogue in preparation)</i>
⑥ 4.161...	Motor flange	<i>(catalogue in preparation)</i>
⑦ 4.171...	Synchronising unit	<i>(catalogue in preparation)</i>
⑧ 4.181...	Gearbox unit	<i>(catalogue in preparation)</i>

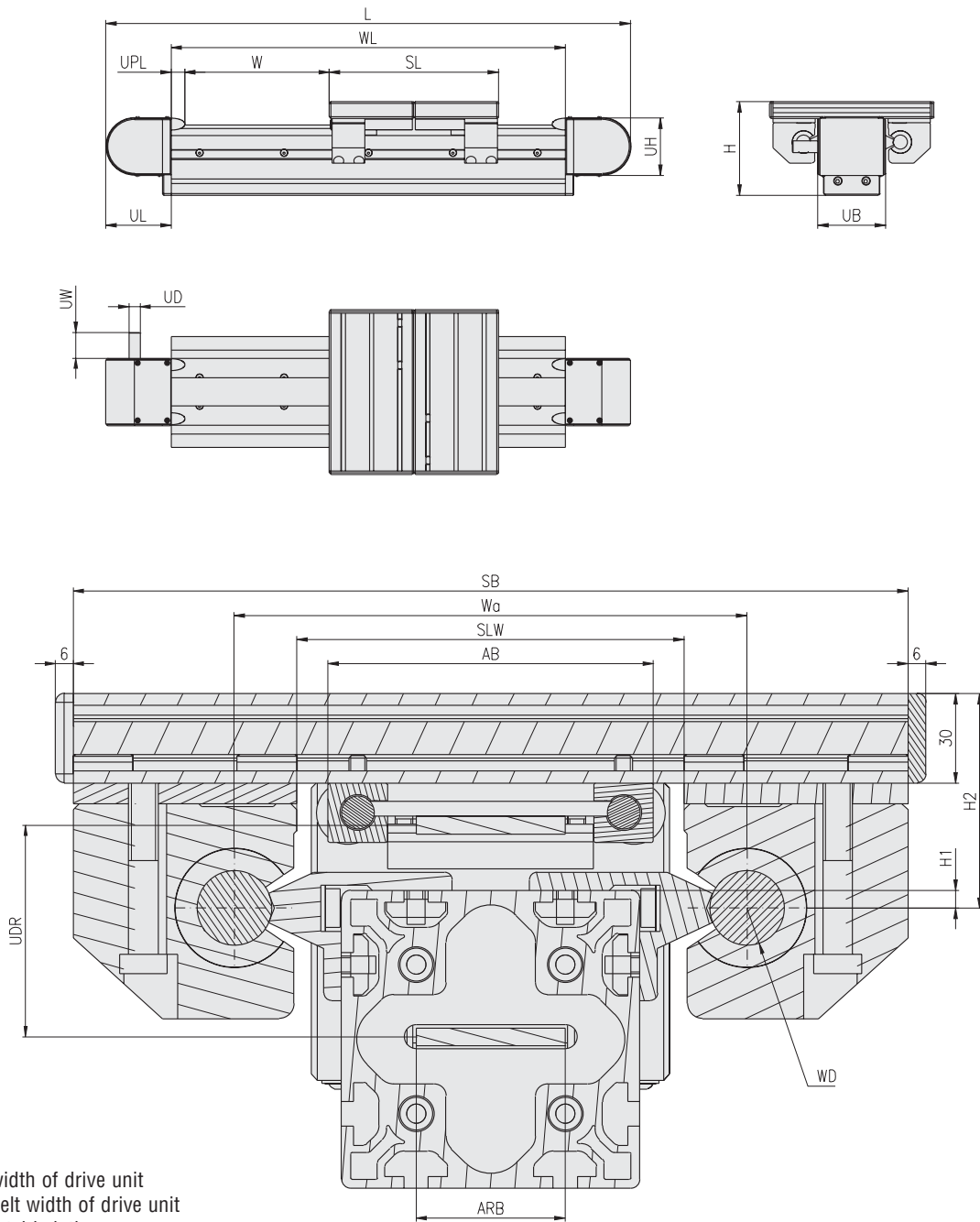

- AB = width of drive unit
- ARB = belt width of drive unit
- H = total height
- H1 = height from shaft center to upper edge of profile
- H2 = height from shaft center to upper edge of carriage
- L = total length
- SB = width of carriage
- SC = center distance from ball bearing to carriage
- SLW = clear width of carriage
- UB = width of turning unit
- UD = shaft end diameter of turning unit
- UDR = pinion diameter of turning unit
- UH = height of turning unit
- UL = length of turning unit
- UPL = parabolic spring length of turning unit
- UW = shaft end length of turning unit
- W = lift
- Wa = axle distance of shaft guidance
- WD = diameter of shaft guidance
- WL = profile length of shaft guidance

Linear unit complete







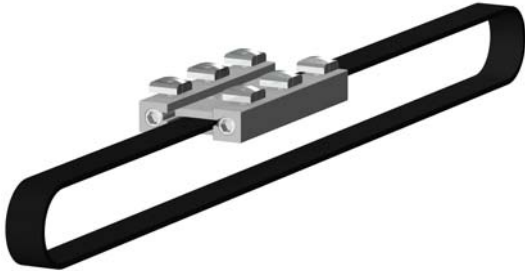

Linear shaft guidance

Shaft-Ø: 12 16 20 25	Single sided shaft		Double sided shaft	
	horizontal	vertical	horizontal	vertical
	Frame design		Single profile design	

Carriage unit

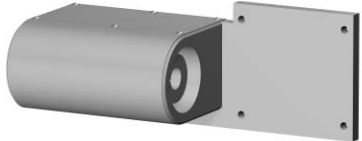
Base plate	Alu plate	Profile 30x150			Profiles 30x60, 30x150
		1 piece	2 pieces	3 pieces	
Bearing Shaft-Ø: 12 16 20 25	fixed	Roller		Sliding or ball bearing guides	
			adjustable topside	adjustable underside	

Drive unit		
Type of toothed belt:	5M	8M
width of toothed belt:	15	20
	25	30
		50
		



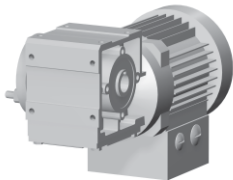
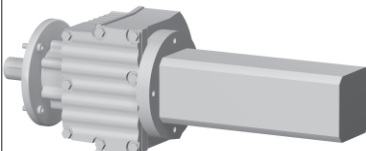
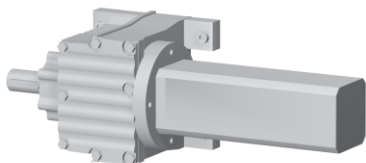

Turning unit			
	for motor with hollow shaft	for motor with shaft and flange	for motor with shaft and base
			
Size: 60 100 150	without shaft	with sigle sided shaft	with double sided shaft
			

Motor		
	Motor with hollow shaft	Motor with shaft and flange
		
		Motor with shaft and base
		

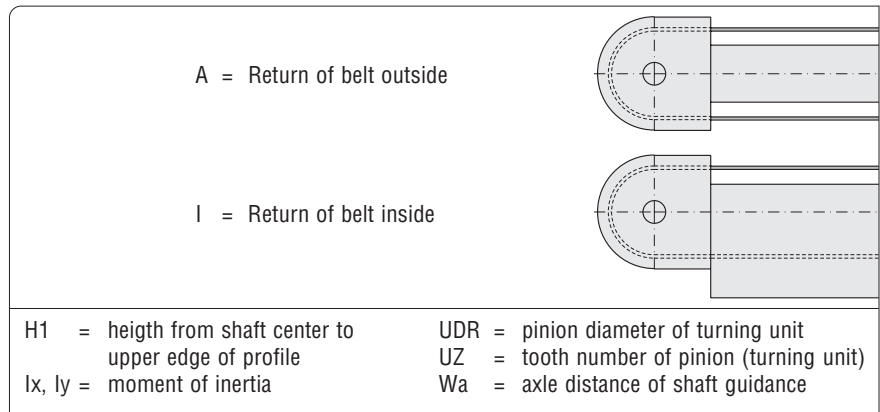
Linear unit complete with toothed belt drive

Shaft guidance horizontal



Linear unit complete		Linear shaft guidance						Turning unit					
Design	Article-No.	Profile Dim.	Technical data					Type	Belt 5M		Type	Belt 8M	
			WD	Wa	H1	lx	ly		UZ	UDR		UZ	UDR
	4.101.030030.43NH22.12...	30x30	12	74	4	14	60	100	36	56.2	100		
	4.101.030030.43NH22.16...	30x30	16	82	3	16	104	100	36	56.2	100		
	4.101.040040.43NH22.12...	40x40	12	84	4	34	95	100	40	62.5	100	30	75.1
	4.101.040040.43NH22.16...	40x40	16	92	3	37	149	100	40	62.5	100	28	70.1
	4.101.040040.43NH22.20...	40x40	20	104	4	44	263	100	44	68.9	100	30	75.1
	4.101.040040.43NH22.25...	40x40	25	112	6	47	421	100	44	68.9	100	30	75.1
	4.101.045045.43NH22.12...	45x45	12	89	4	43	113	100	44	68.9	100	30	75.1
	4.101.045045.43NH22.16...	45x45	16	97	3	47	173	100	44	68.9	100	30	75.1
	4.101.045045.43NH22.20...	45x45	20	109	4	54	299	100	44	68.9	100	32	80.2
	4.101.045045.43NH22.25...	45x45	25	117	6	56	470	100	44	68.9	100	32	80.2
	4.101.050050.43NH22.12...	50x50	12	94	4	60	138	100	48	75.3	100	34	85.2
	4.101.050050.43NH22.16...	50x50	16	102	3	65	203	100	48	75.3	100	32	80.2
	4.101.050050.43NH22.20...	50x50	20	114	4	74	342	100	48	75.3	100	34	85.2
	4.101.050050.43NH22.25...	50x50	25	122	6	77	526	100	48	75.3	100	34	85.2
	4.101.060060.83LNH22.12...	60x60 L	12	104	4	76	182	100	36	56.2	100	22	54.7
	4.101.060060.83LNH22.16...	60x60 L	16	112	3	80	258	100	36	56.2	100	22	54.7
	4.101.080080.83NH22.12...	80x80	12	124	4	246	377	100	36	56.2	100	24	59.8
	4.101.080080.83NH22.16...	80x80	16	132	3	253	475	100	40	62.5	100	26	64.8
	4.101.080080.83NH22.20...	80x80	20	144	4	283	703	100	40	62.5	100	26	64.8
	4.101.080080.83NH22.25...	80x80	25	152	6	293	984	100	40	62.5	100	26	64.8
	4.101.090090.83LNH22.12...	90x90 L	12	134	4	294	455	100	40	62.5	100	26	64.8
	4.101.090090.83LNH22.16...	90x90 L	16	142	3	309	585	100	40	62.5	100	26	64.8
	4.101.090090.83LNH22.20...	90x90 L	20	154	4	335	829	100	44	68.9	100	28	70.1
	4.101.090090.83LNH22.25...	90x90 L	25	162	6	346	1,148	100	44	68.9	100	28	70.1
	4.101.090090.83NH22.12...	90x90	12	134	4	408	547	150	72	113.5	150	48	120.9
	4.101.090090.83NH22.16...	90x90	16	142	3	430	677	150	72	113.5	150	48	120.9
	4.101.090090.83NH22.20...	90x90	20	154	4	468	921	150	72	113.5	150	48	120.9
	4.101.090090.83NH22.25...	90x90	25	162	6	488	1,240	150	72	113.5	150	48	120.9
	4.101.100100.83NH22.12...	100x100	12	144	4	558	717	100	44	68.9	100	28	70.1
	4.101.100100.83NH22.16...	100x100	16	152	3	583	850	100	44	68.9	100	28	70.1
	4.101.100100.83NH22.20...	100x100	20	164	4	635	1,143	100	48	75.3	100	30	75.1
	4.101.100100.83NH22.25...	100x100	25	172	6	661	1,501	100	48	75.3	100	30	75.1
	4.101.030050.44HH22.12...	30x50	12	94	4	19	120	100	36	56.2	100	24	59.8
	4.101.030050.44HH22.16...	30x50	16	102	3	21	186	100	36	56.2	100	24	59.8
	4.101.030060.64HH22.12...	30x60	12	104	4	17	158	100	36	56.2	100	22	54.7
	4.101.030060.64HH22.16...	30x60	16	112	3	18	235	100	36	56.2	100	22	54.7
	4.101.030100.84HH22.12...	30x100	12	144	4	24	421	100	36	56.2	100	22	54.7
	4.101.030100.84HH22.16...	30x100	16	152	3	26	554	100	36	56.2	100	22	54.7
	4.101.030150.84HH22.12...	30x150	12	194	4	40	1,115	100	36	56.2	100	22	54.7
	4.101.030150.84HH22.16...	30x150	16	202	3	42	1,341	100	36	56.2	100	22	54.7
	4.101.040080.65HH22.12...	40x80	12	124	4	47	308	100	24	37.1	100	28	70.1
	4.101.040080.65HH22.16...	40x80	16	132	3	49	420	100	24	37.1	100	28	70.1
	4.101.040080.65HH22.20...	40x80	20	144	4	56	634	100	40	62.5	100	28	70.1
	4.101.040080.65HH22.25...	40x80	25	152	6	58	915	100	40	62.5	100	28	70.1

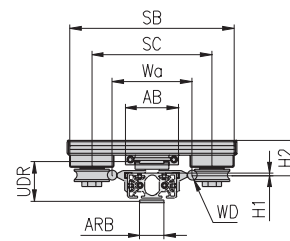
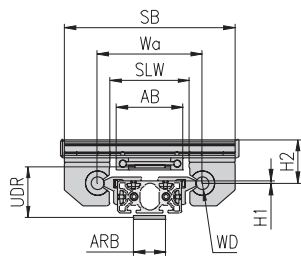

WD = diameter of shaft guidance
 AB = width of drive unit
 ARB = belt width of drive unit

H2 = height from shaft center to upper edge of carriage
 SB = width of carriage



SC = center distance from ball bearing to carriage
 SLW = clear width of carriage

Carriage																			
Ball bearing guide										Wheel guide									
Return of belt 5M					Return of belt 8M					Return of belt 5M					Return of belt 8M				
15	25	20	30	50	SLW	AB	SB	ARB	H2	15	25	20	30	50	SC	AB	SB	ARB	H2
A					52	72	134	15	65	A					117.5	72	168	15	65
										A					145	72	183	15	65
A					62	72	144	15	65	A	A				127.5	87	178	25	65
A					66	72	166	15	65	A	A				155	87	225	25	65
A					70	72	190	15	72	A	A	A	A		186	96	276	30	72
A					70	72	220	15	72	A	A	A	A		199	109	289	50	72
A					67	72	149	15	65	A	A				132.5	83	183	25	65
A					71	72	171	15	65	A	A	A	A		160	90	230	30	65
A					75	72	195	15	72	A	A	A	A		191	101	281	40	72
A					75	72	225	15	72	A	A	A	A		204	114	294	50	72
A					72	72	154	15	65	A	A	A	A		137.5	107	207	40	65
A					76	72	176	15	65	A	A	A	A		165	95	235	30	65
A		A			80	72	200	20	72	A	A	A	A	A	196	106	286	50	72
A		A			80	72	230	20	72	A	A	A	A	A	209	119	299	50	72
I	I				82	82	164	25	65	I	I	I	I		147.5	98	198	40	65
I	I				86	85	186	25	65	I	I	I	I		175	105	245	40	65
I	I	I	I	I	102	100	184	50	65	I	I	I	I	I	167.5	118	218	50	65
I	I	I	I	I	106	105	206	50	65	I	I	I	I	I	195	125	265	60	65
I	I	I	I	I	110	109	230	50	72	I	I	I	I	I	226	136	316	75	72
I	I	I	I	I	110	109	260	50	72	I	I	I	I	I	239	149	329	90	72
I	I	I	I	I	112	110	194	50	65	I	I	I	I	I	177.5	128	228	70	65
I	I	I	I	I	116	115	216	50	65	I	I	I	I	I	205	135	275	75	65
I	I	I	I	I	120	115	240	60	72	I	I	I	I	I	236	146	326	85	72
I	I	I	I	I	120	115	270	60	72	I	I	I	I	I	249	159	339	100	72
A	A	A	A	A	112	110	194	50	65	A	A	A	A	A	177.5	128	228	70	65
A	A	A	A	A	116	115	216	50	65	A	A	A	A	A	205	135	275	75	65
A	A	A	A	A	120	115	240	60	72	A	A	A	A	A	236	146	326	85	72
A	A	A	A	A	120	115	270	60	72	A	A	A	A	A	249	159	339	100	72
I	I	I	I	I	122	120	204	60	65	I	I	I	I	I	187.5	138	238	75	65
I	I	I	I	I	126	125	226	65	65	I	I	I	I	I	215	145	285	85	65
I	I	I	I	I	130	125	250	70	72	I	I	I	I	I	246	156	336	95	72
I	I	I	I	I	130	125	280	70	72	I	I	I	I	I	259	169	349	110	72
A					72	72	154	15	65	A	A	A			137.5	88	188	25	65
A					76	72	176	15	65	A	A	A	A		165	95	235	30	65
A					82	82	164	25	65	A	A	A	A		147.5	98	198	40	65
A					86	82	186	25	65	A	A	A	A		175	105	245	45	65
A	A	A	A	A	122	120	204	60	65	A	A	A	A	A	187.5	138	238	75	65
A	A	A	A	A	126	125	226	65	65	A	A	A	A	A	215	145	285	85	65
A	A	A	A	A	172	170	254	110	65	A	A	A	A	A	237.5	188	288	130	65
A	A	A	A	A	176	175	276	115	65	A	A	A	A	A	265	195	335	135	65
I		A	A		102	100	184	40	65	I		A	A	A	167.5	118	218	60	65
I		A	A		106	105	206	45	65	I		A	A	A	195	125	265	65	65
A	A	A	A	A	110	105	230	50	72	A	A	A	A	A	226	136	316	75	72
A	A	A	A	A	110	105	260	50	72	A	A	A	A	A	239	149	329	90	72

Linear unit complete with toothed belt drive

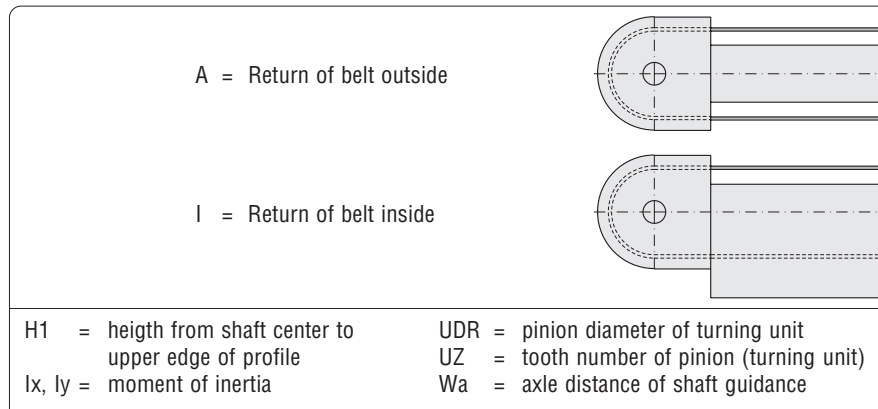
Shaft guidance horizontal



Linear unit complete		Linear shaft guidance						Turning unit					
Design	Article-No.	Profile	Technical data					Type	Belt 5M		Type	Belt 8M	
		Dim.	WD	Wa	H1	lx	ly		UZ	UDR		UZ	UDR
	4.101.040120.84LHH22.12...	40x120 L	12	164	4	49	659	100	44	68.9	100	28	70.1
	4.101.040120.84LHH22.16...	40x120 L	16	172	3	52	826	100	44	68.9	100	28	70.1
	4.101.040120.84LHH22.20...	40x120 L	20	184	4	59	1,199	100	44	68.9	100	28	70.1
	4.101.040120.84LHH22.25...	40x120 L	25	192	6	61	1,643	100	44	68.9	100	28	70.1
	4.101.040160.104LHH22.12...	40x160 L	12	204	4	62	1,263	60	24	37.1	100	28	70.1
	4.101.040160.104LHH22.16...	40x160 L	16	212	3	65	1,510	60	24	37.1	100	28	70.1
	4.101.040160.104LHH22.20...	40x160 L	20	224	4	73	207	60	24	37.1	100	28	70.1
	4.101.040160.104LHH22.25...	40x160 L	25	232	6	75	2,716	60	24	37.1	100	28	70.1
	4.101.045090.64HH22.12...	45x90	12	134	4	63	403	60	24	37.1	100	30	75.1
	4.101.045090.64HH22.16...	45x90	16	142	3	67	532	60	24	37.1	100	30	75.1
	4.101.045090.64HH22.20...	45x90	20	154	4	75	777	60	24	37.1	100	30	75.1
	4.101.045090.64HH22.25...	45x90	25	162	6	77	1,095	60	24	37.1	100	30	75.1
4.101.050100.65HH22.12...	50x100	12	144	4	93	530	60	28	43.4	100	32	80.2	
4.101.050100.65HH22.16...	50x100	16	152	3	98	663	60	28	43.4	100	32	80.2	
4.101.050100.65HH22.20...	50x100	20	164	4	109	956	60	28	43.4	100	32	80.2	
4.101.050100.65HH22.25...	50x100	25	172	6	112	1,314	60	28	43.4	100	32	80.2	
4.101.050150.65HH22.12...	50x150	12	194	4	122	1,313	100	48	75.3	100	32	80.2	
4.101.050150.85HH22.16...	50x150	16	202	3	129	1,539	100	48	75.3	100	32	80.2	
4.101.050150.85HH22.20...	50x150	20	214	4	141	2,052	100	48	75.3	100	32	80.2	
4.101.050150.85HH22.25...	50x150	25	222	6	144	2,640	100	48	75.3	100	32	80.2	
4.101.080160.124HH22.12...	80x160	12	204	4	380	1,688	60	44	68.9	150	44	110.7	
4.101.080160.124HH22.16...	80x160	16	212	3	397	1,936	60	44	68.9	150	44	110.7	
4.101.080160.124HH22.20...	80x160	20	224	4	430	2,500	100	60	94.4	150	44	110.7	
4.101.080160.124HH22.25...	80x160	25	232	6	446	3,142	100	60	94.4	150	44	110.7	
4.101.100200.124HH22.12...	100x200	12	244	4	953	3,717	100	60	94.4	150	56	141.2	
4.101.100200.124HH22.16...	100x200	16	252	3	985	4,060	100	60	94.4	150	56	141.2	
4.101.100200.124HH22.20...	100x200	20	264	4	1,055	4,858	150	60	94.4	150	56	141.2	
4.101.100200.124HH22.25...	100x200	25	272	6	1,096	5,733	150	72	113.5	150	56	141.2	
	4.101.030050.44VH22.12...	30x50	12	74	4	44	66	100	48	75.3			
	4.101.030050.44VH22.16...	30x50	16	82	3	48	109	100	48	75.3			
	4.101.030060.64VH22.12...	30x60	12	74	4	62	67	60	30	46.6			
	4.101.030060.64VH22.16...	30x60	16	82	3	67	110	60	30	46.6			
	4.101.030100.84VH22.12...	30x100	12	74	4	229	70	100	36	56.2	150	56	141.2
	4.101.030100.84VH22.16...	30x100	16	82	3	247	114	100	36	56.2	150	56	141.2
	4.101.040080.65VH22.12...	40x80	12	84	4	160	105	100	40	62.5	100	26	64.8
	4.101.040080.65VH22.16...	40x80	16	92	3	172	159	100	40	62.5	100	26	64.8
	4.101.040080.65VH22.20...	40x80	20	104	4	191	274	100	40	62.5	100	26	64.8
	4.101.040080.65VH22.25...	40x80	25	112	6	196	4,317	100	40	62.5	150	48	120.9
	4.101.040120.84LVH22.12...	40x120 L	12	84	4	374	108	100	40	62.5	100	26	64.8
	4.101.040120.84LVH22.16...	40x120 L	16	92	3	399	162	100	40	62.5	100	26	64.8
4.101.040120.84LVH22.20...	40x120 L	20	104	4	436	277	100	40	62.5	100	26	64.8	
4.101.040120.84LVH22.25...	40x120 L	25	112	6	450	434	100	40	62.5	100	26	64.8	

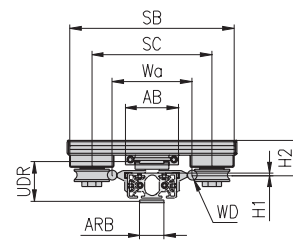
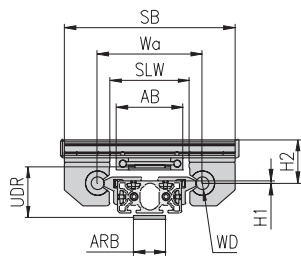

WD = diameter of shaft guidance
 AB = width of drive unit
 ARB = belt width of drive unit

H2 = height from shaft center to upper edge of carriage
 SB = width of carriage

SC = center distance from ball bearing to carriage
 SLW = clear width of carriage

Carriage																			
Ball bearing guide										Wheel guide									
Return of belt 5M										Return of belt 8M									
15	25	20	30	50	SLW	AB	SB	ARB	H2	15	25	20	30	50	SC	AB	SB	ARB	H2
A	A	A	A	A	142	140	224	80	65	A	A	A	A	A	207.5	158	258	100	65
A	A	A	A	A	146	145	246	85	65	A	A	A	A	A	235	165	305	100	65
A	A	A	A	A	150	145	270	90	72	A	A	A	A	A	266	176	356	115	72
A	A	A	A	A	150	145	300	90	72	A	A	A	A	A	279	189	369	130	72
I	I	A	A	A	182	180	264	120	65	I		A	A	A	247.5	198	298	140	65
I	I	A	A	A	186	185	286	125	65	I		A	A	A	275	205	345	145	65
i	A	A	A	A	190	185	310	130	72	A	A	A	A	A	306	216	396	150	72
I	A	A	A	A	190	185	340	130	72	A	A	A	A	A	319	229	409	170	72
I		A	A	A	112	110	194	50	65	I		A	A	A	177.5	128	228	70	65
I		A	A	A	116	115	216	50	65	I		A	A	A	205	135	275	75	65
I	A	A	A	A	120	115	240	60	72	A	A	A	A	A	236	146	326	85	72
I	A	A	A	A	120	115	270	60	72	A	A	A	A	A	249	159	339	100	72
I	A	A	A	A	122	120	204	60	65	I	A	A	A	A	187.5	138	238	80	65
I	I	A	A	A	126	125	226	65	65	I	I	A	A	A	215	145	285	85	65
I	I	A	A	A	130	125	250	70	72	I	I	A	A	A	246	156	336	95	72
I	A	A	A	A	130	125	280	70	72	I	A	A	A	A	259	169	349	110	72
A	A	A	A	A	172	170	254	110	65	A	A	A	A	A	237.5	188	288	130	65
A	A	A	A	A	176	175	276	115	65	A	A	A	A	A	265	195	335	135	65
A	A	A	A	A	180	175	300	120	72	A	A	A	A	A	296	206	386	145	72
A	A	A	A	A	180	175	330	120	72	A	A	A	A	A	309	219	399	160	72
I		A	A	A	182	180	264	120	65	I		A	A	A	247.5	198	298	140	65
I		A	A	A	186	185	286	125	65	I		A	A	A	275	205	345	145	65
A	A	A	A	A	190	115	310	130	72	A	A	A	A	A	306	216	396	150	72
A	A	A	A	A	190	185	340	130	72	A	A	A	A	A	319	229	409	170	72
I	I	A	A	A	222	220	304	160	65	I	I	A	A	A	287.5	238	338	180	65
I	I	A	A	A	226	225	326	160	65	I	I	A	A	A	315	245	385	185	65
I	I	A	A	A	230	225	350	170	72	I	I	A	A	A	346	256	436	195	72
A	A	A	A	A	230	225	380	170	72	A	A	A	A	A	359	269	449	210	72
A					52	72	134	15	65	A					117.5	72	168	15	65
										A					145	72	183	15	65
I					52	72	134	15	65	I					117.5	72	168	15	65
										I					145	72	183	15	65
I					52	72	134	15	65	I					117.5	72	168	15	65
										I					145	72	183	15	65
I					62	72	144	15	65	I	I	I			127.5	87	187	25	65
I					66	72	166	15	65	I	I	I			155	87	225	25	65
I					70	72	190	15	72	I	I	I	I		186	96	276	30	72
I					70	72	220	15	72	I	I	I	I	A	199	109	289	50	72
I					62	72	144	15	65	I	I	I			127.5	87	187	25	65
I					66	72	166	15	65	I	I	I			155	87	225	25	65
I					70	72	190	15	72	I	I	I	I		186	96	276	30	72
I					70	72	220	15	72	I	I	I	I		199	109	289	50	72

Linear unit complete with toothed belt drive

Shaft guidance horizontal

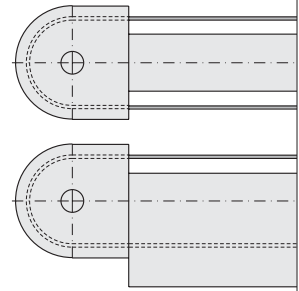

A = Return of belt outside

I = Return of belt inside



H1 = height from shaft center to upper edge of profile
 Ix, Iy = moment of inertia

UDR = pinion diameter of turning unit
 UZ = tooth number of pinion (turning unit)
 Wa = axle distance of shaft guidance

Linear unit complete		Linear shaft guidance						Turning unit					
Design	Article-No.	Profile Dim.	Technical data					Type	Belt 5M		Type	Belt 8M	
			WD	Wa	H1	Ix	Iy		UZ	UDR		UZ	UDR
	4.101.040160.104LVH22.12...	40x160 L	12	84	4	857	118	100	40	62.5	100	26	64.8
	4.101.040160.104LVH22.16...	40x160 L	16	92	3	915	172	100	40	62.5	100	26	64.8
	4.101.040160.104LVH22.20...	40x160 L	20	104	4	1,010	287	100	40	62.5	100	26	64.8
	4.101.040160.104LVH22.25...	40x160 L	25	112	6	1,056	444	100	40	62.5	100	26	64.8
	4.101.045090.64VH22.12...	45x90	12	89	4	234	129	100	44	68.9	100	28	70.1
	4.101.045090.64VH22.16...	45x90	16	97	3	251	189	100	44	68.9	100	28	70.1
	4.101.045090.64VH22.20...	45x90	20	109	4	277	315	100	44	68.9	100	28	70.1
	4.101.045090.64VH22.25...	45x90	25	117	6	286	486	100	44	68.9	150	56	141.2
	4.101.050100.65VH22.12...	50x100	12	94	4	344	165	100	44	68.9	100	28	70.1
	4.101.050100.65VH22.16...	50x100	16	102	3	369	231	100	44	68.9	100	28	70.1
	4.101.050100.65VH22.20...	50x100	20	114	4	409	369	100	44	68.9	100	28	70.1
	4.101.050100.65VH22.25...	50x100	25	122	6	424	554	100	44	68.9	150	56	141.2
	4.101.050150.65VH22.12...	50x150	12	94	4	996	191	100	44	68.9	100	28	70.1
	4.101.050150.85VH22.16...	50x150	16	102	3	1,062	257	100	44	68.9	100	28	70.1
	4.101.050150.85VH22.20...	50x150	20	114	4	1,174	395	100	44	68.9	100	28	70.1
	4.101.050150.85VH22.25...	50x150	25	122	6	1,232	580	100	44	68.9	150	56	141.2
	4.101.080160.124VH22.12...	80x160	12	124	4	1,376	496	100	40	62.5	100	26	64.8
	4.101.080160.124VH22.16...	80x160	16	132	3	1,441	599	100	40	62.5	100	26	64.8
	4.101.080160.124VH22.20...	80x160	20	144	4	1,580	822	100	40	62.5	100	26	64.8
	4.101.080160.124VH22.25...	80x160	25	152	6	1,666	1,104	100	40	62.5	100	26	64.8
	4.101.100200.124VH22.12...	100x200	12	144	4	3,370	1,088	100	48	75.3	100	30	75.1
	4.101.100200.124VH22.16...	100x200	16	152	3	3,499	1,221	100	48	75.3	100	30	75.1
	4.101.100200.124VH22.20...	100x200	20	164	4	3,799	1,514	100	48	75.3	100	30	75.1
	4.101.100200.124VH22.25...	100x200	25	172	6	4,007	1,872	100	48	75.3	100	30	75.1

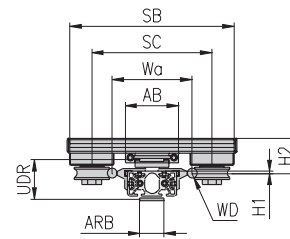
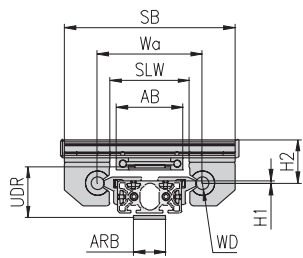

WD = diameter of shaft guidance
 AB = width of drive unit
 ARB = belt width of drive unit

H2 = height from shaft center to upper edge of carriage
 SB = width of carriage

SC = center distance from ball bearing to carriage
 SLW = clear width of carriage

Carriage																			
Ball bearing guide										Wheel guide									
Return of belt 5M										Return of belt 8M									
15	25	20	30	50	SLW	AB	SB	ARB	H2	15	25	20	30	50	SC	AB	SB	ARB	H2
					62	72	144	15	65						127.5	87	187	25	65
					66	72	166	15	65						155	87	225	25	65
					70	72	190	15	72						186	96	276	30	72
					70	72	220	15	72						199	109	289	50	72
					67	72	149	15	65						132.5	83	183	25	65
					71	72	171	15	65						160	90	230	30	65
					75	72	195	15	72						191	101	281	40	72
					75	72	225	15	72					A	204	114	294	50	72
					72	72	154	15	65						137.5	88	188	25	65
					76	72	176	15	65						165	95	235	30	65
					80	72	200	15	72					A	196	106	286	50	72
					80	72	230	15	72					A	209	119	299	50	72
					72	72	154	15	65						137.5	88	188	25	65
					76	72	176	15	65						165	95	235	30	65
					80	82	200	25	72						196	106	286	50	72
					80	82	230	25	72						209	119	299	50	72
					102	100	184	30	65						167.5	118	218	50	65
					106	105	206	50	65						195	125	265	65	65
					110	105	230	50	72						226	136	316	75	72
					110	105	260	50	72						239	149	329	90	72
					122	120	204	60	65						187.5	138	238	75	65
					126	125	226	65	65						215	145	285	85	65
					130	125	250	70	72						246	156	336	95	72
					130	125	280	70	72						259	169	349	110	72

Linear unit complete with toothed belt drive

Shaft guidance vertical

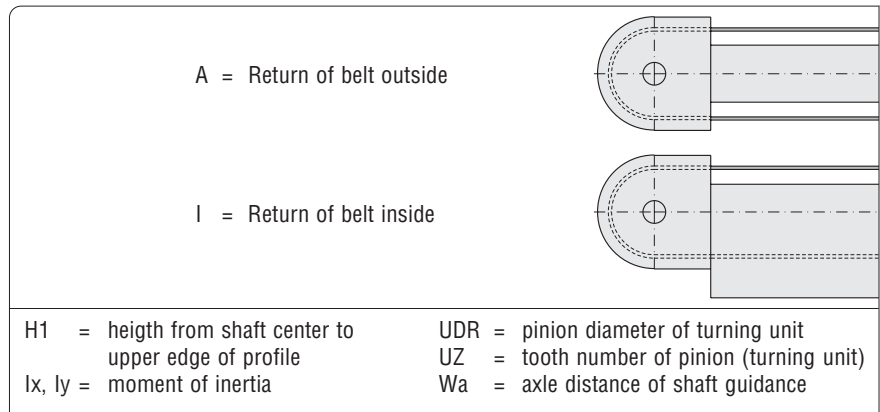

Linear unit complete		Linear shaft guidance						Turning unit					
Design	Article-No.	Profile Dim.	Technical data					Type	Belt 5M		Type	Belt 8M	
			WD	Wa	H1	lx	ly		UZ	UDR		UZ	UDR
	4.101.090090.83LNV22.12...	90x90 L	12	82	22	356	364	100	60	94.4	100	34	85.2
	4.101.090090.83LNV22.16...	90x90 L	16	84	26	424	405	100	60	94.4	150	38	95.4
	4.101.090090.83LNV22.20...	90x90 L	20	82	32	533	484	150	72	113.5	150	40	100.5
	4.101.090090.83LNV22.25...	90x90 L	25	78	36	659	542	150	72	113.5	150	44	110.7
	4.101.090090.83NV22.12...	90x90	12	82	22	480	456	100	60	94.4	150	56	141.2
	4.101.090090.83NV22.16...	90x90	16	84	26	565	496					64	161.6
	4.101.100100.83NV22.12...	100x100	12	92	22	637	617	100	60	94.4	150	38	95.4
	4.101.100100.83NV22.16...	100x100	16	94	26	727	661	100	60	94.4	100	36	90.3
4.101.100100.83NV22.20...	100x100	20	92	32	897	767	150	72	113.5	150	44	110.7	
4.101.100100.83NV22.25...	100x100	25	88	36	1,087	842	150	72	113.5	150	48	120.9	
	4.101.030100.84HV22.12...	30x100	12	92	22	50	321	100	60	94.4	100	32	80.2
	4.101.030100.84HV22.16...	30x100	16	94	26	75	37	100	60	94.4	100	36	90.3
	4.101.030150.84HV22.12...	30x150	12	142	22	71	971	100	60	94.4	100	32	80.2
	4.101.030150.84HV22.16...	30x150	16	144	26	102	1,072	100	60	94.4	100	36	90.3
	4.101.040120.84LHV22.12...	40x120 L	12	112	22	82	82	100	60	94.4	100	36	90.3
	4.101.040120.84LHV22.16...	40x120 L	16	114	26	113	606	100	60	94.4	150	38	95.4
	4.101.040120.84LHV22.20...	40x120 L	20	112	32	170	762	150	72	113.5	150	44	110.7
	4.101.040120.84LHV22.25...	40x120 L	25	108	36	237	879	150	72	113.5	150	48	120.9
	4.101.040160.104LHV22.12...	40x160 L	12	152	22	98	1,111	100	40	62.5	100	36	90.3
	4.101.040160.104LHV22.16...	40x160 L	16	154	26	133	1,225	100	44	68.9	150	40	100.5
	4.101.040160.104LHV22.20...	40x160 L	20	152	32	198	1,515	150	72	113.5	150	44	110.7
	4.101.040160.104LHV22.25...	40x160 L	25	148	36	277	1,742	150	72	113.5	150	48	120.9
	4.101.045090.64HV22.12...	45x90	12	82	22	100	312	100	44	68.9	150	38	95.4
	4.101.045090.64HV22.16...	45x90	16	84	26	135	347	100	48	75.3	150	44	110.7
	4.101.045090.64HV22.20...	45x90	20	82	32	200	431	150	72	113.5	150	44	110.7
	4.101.045090.64HV22.25...	45x90	25	78	36	276	489	150	72	113.5	150	48	120.9
	4.101.050100.65HV22.12...	50x100	12	92	22	135	430	100	40	62.5	150	40	100.5
	4.101.050100.65HV22.16...	50x100	16	94	26	176	474	100	44	68.9	150	44	110.7
	4.101.050100.65HV22.20...	50x100	20	92	32	252	580	100	48	75.3	100	32	80.2
	4.101.050100.65HV22.25...	50x100	25	88	36	341	655	150	72	113.5	150	56	141.2
	4.101.050150.85HV22.12...	50x150	12	142	22	167	1,170	150	72	113.5	150	40	100.5
	4.101.050150.85HV22.16...	50x150	16	144	26	213	1,270	150	72	113.5	150	44	110.7
	4.101.050150.85HV22.20...	50x150	20	142	32	298	1,523	150	72	113.5	150	48	120.9
	4.101.050150.85HV22.25...	50x150	25	138	36	400	1,719	150	72	113.5	150	56	141.2
4.101.080160.124HV22.12...	80x160	12	152	22	446	1,536	100	40	62.5	150	56	141.2	
4.101.080160.124HV22.16...	80x160	16	154	26	519	1,651	100	44	68.9	150	56	141.2	
4.101.080160.124HV22.20...	80x160	20	152	32	656	1,941	100	48	75.3		64	161.6	
4.101.080160.124HV22.25...	80x160	25	148	36	814	2,168					64	161.6	
4.101.100200.124HV22.12...	100x200	12	192	22	1,040	3,530	100	40	62.5		64	161.6	
4.101.100200.124HV22.16...	100x200	16	194	26	1,147	3,711	100	48	75.3		64	161.6	
4.101.100200.124HV22.20...	100x200	20	192	32	1,359	4,176	100	48	75.3		72	182.0	
4.101.100200.124HV22.25...	100x200	25	188	36	1,603	4,550	100	48	75.3		72	182.0	
	4.101.100200.124VV22.12...	100x200	12	92	22	3,531	988	100	60	94.4	150	38	95.4
	4.101.100200.124VV22.16...	100x200	16	94	26	3,792	1,032	100	60	94.4	100	36	90.3
	4.101.100200.124VV22.20...	100x200	20	92	32	4,340	1,138	150	72	113.5	150	44	110.7
	4.101.100200.124VV22.25...	100x200	25	88	36	4,901	1,213	150	72	113.5	150	48	120.9

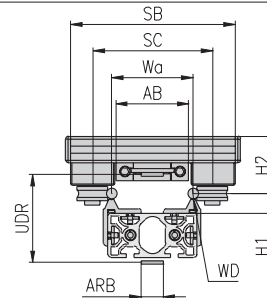
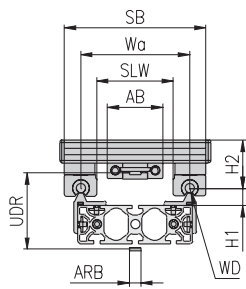

WD = diameter of shaft guidance
 AB = width of drive unit
 ARB = belt width of drive unit

H2 = height from shaft center to upper edge of carriage
 SB = width of carriage

SC = center distance from ball bearing to carriage
 SLW = clear width of carriage

Carriage																			
Ball bearing guide										Wheel guide									
Return of belt					SLW	AB	SB	ARB	H2	Return of belt					SC	AB	SB	ARB	H2
5M		8M								5M		8M							
15	25	20	30	50						15	25	20	30	50					
															125.5	76	176	15	65
															147	77	217	20	65
															164	74	254	15	72
															165	75	255	15	72
										A				A	125.5	76	176	15	65
														A	147	77	217	20	65
															135.5	86	186	25	65
															157	87	227	30	65
															174	84	264	25	72
															175	85	265	25	72
										A	A	A			135.5	86	186	25	65
										A	A	A	A		157	87	227	30	65
A	A	A	A		99	95	188	30	65	A	A	A	A	A	185.5	136	236	75	65
A	A	A	A		91	95	200	30	65	A	A	A	A	A	207	137	277	75	65
A					69	70	158	15	65	A	A	A	A	A	155.5	106	206	50	65
A					61	65	170	15	65	A	A	A	A	A	177	107	247	50	65
										A	A	A	A	A	194	104	284	45	72
										A	A	A	A	A	195	105	285	45	72
		A	A	A	109	105	198	50	65			A	A	A	195.5	146	246	85	65
		A	A		101	100	210	45	65			A	A	A	217	147	287	85	65
A	A	A	A		92	95	215	30	72	A	A	A	A	A	234	144	324	85	72
A					70	70	229	15	72	A	A	A	A	A	235	145	325	85	72
															125.5	76	176	15	65
												A			147	77	217	20	65
															164	74	254	15	72
															165	75	255	15	72
										A	A	A		A	135.5	86	186	25	65
												A	A		157	87	227	30	65
															174	84	264	25	72
										A	A	A			175	85	265	25	72
A	A	A	A		99	95	188	40	65	A	A	A	A	A	185.5	136	236	75	65
A	A	A	A		91	90	200	30	65	A	A	A	A	A	207	137	277	75	65
A	A	A			82	80	205	25	72	A	A	A	A	A	224	134	314	75	72
										A	A	A	A	A	225	135	315	75	72
		A	A	A	109	105	198	50	65			A	A	A	195.5	146	246	85	65
		A	A		101	100	210	45	65			A	A	A	217	147	287	85	65
	A	A	A		92	95	215	30	72			A	A	A	234	144	324	85	72
					70	70	229	15	72						235	145	325	85	72
		A	A	A	149	145	238	90	65			A	A	A	235.5	186	286	125	65
		A	A	A	141	140	250	85	65			A	A	A	257	187	327	130	65
		A	A	A	132	130	255	70	72			A	A	A	274	184	364	125	72
A	A	A	A	A	110	105	269	50	72	A	A	A	A	A	275	185	365	125	72
															135.5	86	186	25	65
															157	87	227	30	65
															174	84	264	25	72
															175	85	265	25	72

Construction form

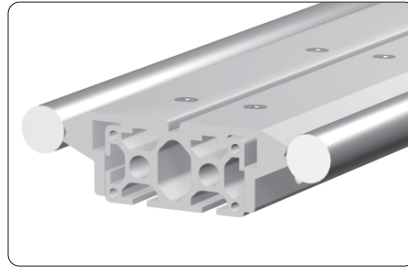

Position
 N = neutral
 H = horizontal
 V = vertical

NH
 (neutral, horizontal)

NV
 (neutral, vertical)

HH
 (horizontal, horizontal)

HV
 (horizontal, vertical)

VH
 (vertical, horizontal)

VV
 (vertical, vertical)

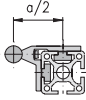
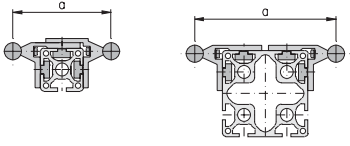
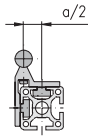
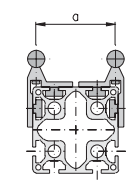
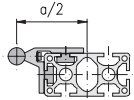
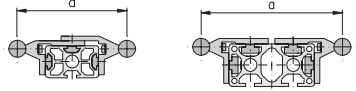
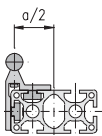
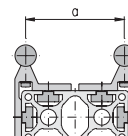
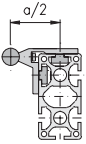
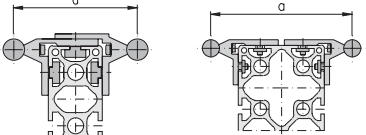
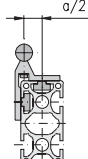
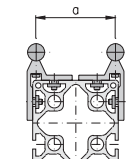
Position		Shaft guidance	
Base profile	Shaft	single sided	double sided
N	H	 1)	
N	V	 1)	
H	H	 2)	
H	V	 3)	
V	H	 3)	
V	V	 2)	

1), 2), 3): identical

Linear shaft guidance, complete

4.119.00.	□□□□□□	.	□□□□□□□□	.	□□	.	□	/	□□□□	Key	
4.119.00.	□□□□□□	.	□□□□□□□□	.	□□	.	□	/	□□□□	Profile	• dimension
4.119.00.	□□□□□□	.	□□□□□□□□	.	□□	.	□	/	□□□□		• orientation ¹⁾
4.119.00.	□□□□□□	.	□□□□□□□□	.	□□	.	□	/	□□□□	Shaft	• orientation ²⁾
4.119.00.	□□□□□□	.	□□□□□□□□	.	□□	.	□	/	□□□□		• number ³⁾
4.119.00.	□□□□□□	.	□□□□□□□□	.	□□	.	□	/	□□□□		• assembly ⁴⁾
4.119.00.	□□□□□□	.	□□□□□□□□	.	□□	.	□	/	□□□□		• Ø
4.119.00.	□□□□□□	.	□□□□□□□□	.	□□	.	□	/	□□□□		• material ⁵⁾
4.119.00.	□□□□□□	.	□□□□□□□□	.	□□	.	□	/	□□□□	Length	

- 1) H = horizontal
N = neutral
V = vertical
- 2) H = horizontal
V = vertical
- 3) 1 = single sided
2 = double sided
- 4) 2 = with guide profile
- 5) Shaft mounting elements
1 = tempering steel steel, galvanised
2 = X46Cr13 steel, galvanised
3 = X46Cr13 VA

LWF-1 complete (Linear shaft guidance, single sided)

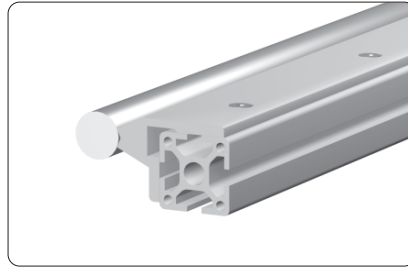

Legend

Descr. = description
 Dim. = dimension
 L1 = orientation of base profile
 L2 = orientation of linear shaft guidance
 \emptyset = diameter of shaft in mm
 a = axle distance in mm
 Ix, Iy = moment of inertia in cm⁴
 G = weight in kg/m

Orientation

N = neutral
 H = horizontal
 V = vertical

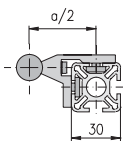

Descr.	Base profile		Shaft			Moment of i.			G	Article-No.
	Dim.	L1	L2	\emptyset	a/2	Ix	Iy	kg/m		
LWF-1	30x30	N	H	12	37	9	20	3.0	4.119.00.030030.43NH12.12...	
LWF-1	30x30	N	H	16	41	9	31	3.7	4.119.00.030030.43NH12.16...	

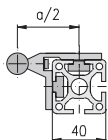

Descr.	Base profile		Shaft			Moment of i.			G	Article-No.
	Dim.	L1	L2	\emptyset	a/2	Ix	Iy	kg/m		
LWF-1	40x40	N	H	12	42	24	40	4.2	4.119.00.040040.43NH12.12...	
LWF-1	40x40	N	H	16	46	25	56	4.9	4.119.00.040040.43NH12.16...	
LWF-1	40x40	N	H	20	52	29	85	6.2	4.119.00.040040.43NH12.20...	
LWF-1	40x40	N	H	25	56	30	119	7.8	4.119.00.040040.43NH12.25...	

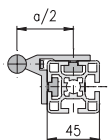

Descr.	Base profile		Shaft			Moment of i.			G	Article-No.
	Dim.	L1	L2	\emptyset	a/2	Ix	Iy	kg/m		
LWF-1	45x45	N	H	12	44.5	32	50	4.5	4.119.00.045045.43NH12.12...	
LWF-1	45x45	N	H	16	48.5	34	68	5.2	4.119.00.045045.43NH12.16...	
LWF-1	45x45	N	H	20	54.5	37	100	6.5	4.119.00.045045.43NH12.20...	
LWF-1	45x45	N	H	25	58.5	39	138	8.1	4.119.00.045045.43NH12.25...	

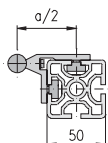

Descr.	Base profile		Shaft			Moment of i.			G	Article-No.
	Dim.	L1	L2	\emptyset	a/2	Ix	Iy	kg/m		
LWF-1	50x50	N	H	12	47	46	67	5.3	4.119.00.050050.43NH12.12...	
LWF-1	50x50	N	H	16	51	49	88	6.0	4.119.00.050050.43NH12.16...	
LWF-1	50x50	N	H	20	57	54	126	7.3	4.119.00.050050.43NH12.20...	
LWF-1	50x50	N	H	25	61	56	172	8.9	4.119.00.050050.43NH12.25...	

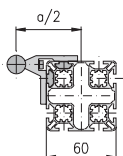

Descr.	Base profile		Shaft			Moment of i.			G	Article-No.
	Dim.	L1	L2	\emptyset	a/2	Ix	Iy	kg/m		
LWF-1	60x60 L	N	H	12	52	64	87	4.7	4.119.00.060060.83LNH12.12...	
LWF-1	60x60 L	N	H	16	56	64	108	5.5	4.119.00.060060.83LNH12.16...	

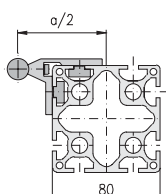

Descr.	Base profile		Shaft			Moment of i.			G	Article-No.
	Dim.	L1	L2	\emptyset	a/2	Ix	Iy	kg/m		
LWF-1	80x80	N	H	12	62	205	239	8.1	4.119.00.080080.83NH12.12...	
LWF-1	80x80	N	H	16	66	209	272	8.8	4.119.00.080080.83NH12.16...	
LWF-1	80x80	N	H	20	72	232	350	10.1	4.119.00.080080.83NH12.20...	
LWF-1	80x80	N	H	25	76	241	435	11.7	4.119.00.080080.83NH12.25...	

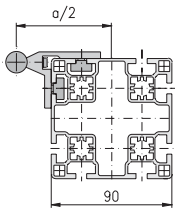

Descr.	Base profile		Shaft		Moment of i.			G	Article-No.	
	Dim.	L1	L2	Ø	a/2	lx	ly			kg/m
LWF-1	90×90	L	N	H	12	67	252	210	7.5	4.119.00.090090.83LNH12.12...
LWF-1	90×90	L	N	H	16	71	280	350	8.2	4.119.00.090090.83LNH12.16...
LWF-1	90×90	L	N	H	20	77	302	432	9.5	4.119.00.090090.83LNH12.20...
LWF-1	90×90	L	N	H	25	81	316	524	11.1	4.119.00.090090.83LNH12.25...

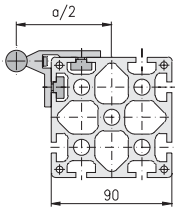

Descr.	Base profile		Shaft		Moment of i.			G	Article-No.	
	Dim.	L1	L2	Ø	a/2	lx	ly			kg/m
LWF-1	90×90		N	H	12	67	346	386	11.7	4.119.00.090090.83NH12.12...
LWF-1	90×90		N	H	16	71	36	437	12.4	4.119.00.090090.83NH12.16...
LWF-1	90×90		N	H	20	77	386	527	13.7	4.119.00.090090.83NH12.20...
LWF-1	90×90		N	H	25	81	402	637	15.3	4.119.00.090090.83NH12.25...

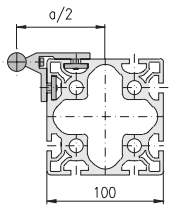

Descr.	Base profile		Shaft		Moment of i.			G	Article-No.	
	Dim.	L1	L2	Ø	a/2	lx	ly			kg/m
LWF-1	100×100		N	H	12	72	479	523	11.9	4.119.00.100100.83NH12.12...
LWF-1	100×100		N	H	16	76	496	577	12.6	4.119.00.100100.83NH12.16...
LWF-1	100×100		N	H	20	82	531	684	13.9	4.119.00.100100.83NH12.20...
LWF-1	100×100		N	H	25	86	552	808	15.5	4.119.00.100100.83NH12.25...

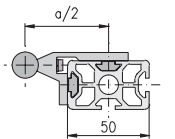

Descr.	Base profile		Shaft		Moment of i.			G	Article-No.	
	Dim.	L1	L2	Ø	a/2	lx	ly			kg/m
LWF-1	30×50		H	H	12	47	13	51	4.1	4.119.00.030050.44HH12.12...
LWF-1	30×50		H	H	16	51	14	69	4.7	4.119.00.030050.44HH12.16...

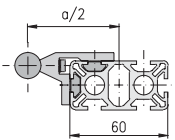

Descr.	Base profile		Shaft		Moment of i.			G	Article-No.	
	Dim.	L1	L2	Ø	a/2	lx	ly			kg/m
LWF-1	30×60		H	H	12	52	13	68	4.2	4.119.00.030060.64HH12.12...
LWF-1	30×60		H	H	16	56	14	87	4.8	4.119.00.030060.64HH12.16...

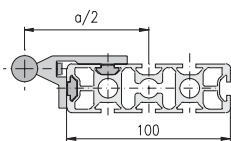

Descr.	Base profile		Shaft		Moment of i.			G	Article-No.	
	Dim.	L1	L2	Ø	a/2	lx	ly			kg/m
LWF-1	30×100		H	H	12	72	19	220	5.5	4.119.00.030100.84HH12.12...
LWF-1	30×100		H	H	16	76	20	260	6.1	4.119.00.030100.84HH12.16...

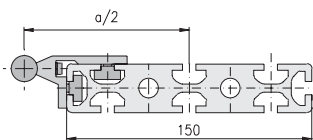

Descr.	Base profile		Shaft		Moment of i.			G	Article-No.	
	Dim.	L1	L2	Ø	a/2	lx	ly			kg/m
LWF-1	30×150		H	H	12	97	33	733	10.0	4.119.00.030150.84HH12.12...
LWF-1	30×150		H	H	16	101	34	819	10.6	4.119.00.030150.84HH12.16...

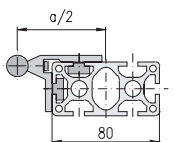

Descr.	Base profile		Shaft		Moment of i.			G	Article-No.	
	Dim.	L1	L2	Ø	a/2	lx	ly			kg/m
LWF-1	40×80		H	H	12	62	36	160	6.0	4.119.00.040080.65HH12.12...
LWF-1	40×80		H	H	16	66	38	193	6.7	4.119.00.040080.65HH12.16...
LWF-1	40×80		H	H	20	72	42	252	8.0	4.119.00.040080.65HH12.20...
LWF-1	40×80		H	H	25	76	44	320	9.6	4.119.00.040080.65HH12.25...

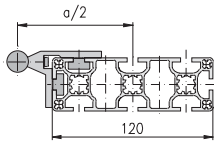

Descr.	Base profile		Shaft		Moment of i.			G	Article-No.
	Dim.	L1	L2	Ø	a/2	lx	ly		
LWF-1	40x120	L H	H	12	82	39	351	5.9	4.119.00.040120.84LHH12.12...
LWF-1	40x120	L H	H	16	86	41	400	6.6	4.119.00.040120.84LHH12.16...
LWF-1	40x120	L H	H	20	92	45	491	7.9	4.119.00.040120.84LHH12.20...
LWF-1	40x120	L H	H	25	96	46	589	9.5	4.119.00.040120.84LHH12.25...

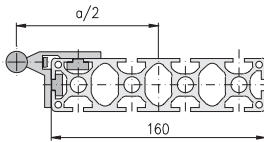

Descr.	Base profile		Shaft		Moment of i.			G	Article-No.
	Dim.	L1	L2	Ø	a/2	lx	ly		
LWF-1	40x160	L H	H	12	102	50	764	7.8	4.119.00.040160.104LHH12.12...
LWF-1	40x160	L H	H	16	106	52	846	8.5	4.119.00.040160.104LHH12.16...
LWF-1	40x160	L H	H	20	112	57	1,007	9.8	4.119.00.040160.104LHH12.20...
LWF-1	40x160	L H	H	25	116	58	1,174	11.4	4.119.00.040160.104LHH12.25...

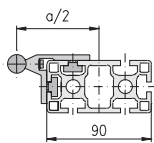

Descr.	Base profile		Shaft		Moment of i.			G	Article-No.
	Dim.	L1	L2	Ø	a/2	lx	ly		
LWF-1	45x90	H	H	12	67	50	226	6.6	4.119.00.045090.64HH12.12...
LWF-1	45x90	H	H	16	71	53	268	7.3	4.119.00.045090.64HH12.16...
LWF-1	45x90	H	H	20	77	58	337	8.6	4.119.00.045090.64HH12.20...
LWF-1	45x90	H	H	25	81	60	420	10.2	4.119.00.045090.64HH12.25...

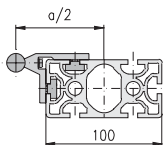

Descr.	Base profile		Shaft		Moment of i.			G	Article-No.
	Dim.	L1	L2	Ø	a/2	lx	ly		
LWF-1	50x100	H	H	12	72	76	324	8.1	4.119.00.050100.65HH12.12...
LWF-1	50x100	H	H	16	76	80	371	8.8	4.119.00.050100.65HH12.16...
LWF-1	50x100	H	H	20	82	87	462	10.1	4.119.00.050100.65HH12.20...
LWF-1	50x100	H	H	25	86	89	565	11.7	4.119.00.050100.65HH12.25...

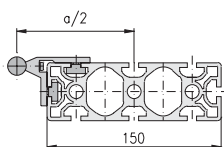

Descr.	Base profile		Shaft		Moment of i.			G	Article-No.
	Dim.	L1	L2	Ø	a/2	lx	ly		
LWF-1	50x150	H	H	12	97	103	894	10.3	4.119.00.050150.85HH12.12...
LWF-1	50x150	H	H	16	101	107	979	11.0	4.119.00.050150.85HH12.16...
LWF-1	50x150	H	H	20	107	115	1,151	12.3	4.119.00.050150.85HH12.20...
LWF-1	50x150	H	H	25	111	118	1,334	13.9	4.119.00.050150.85HH12.25...

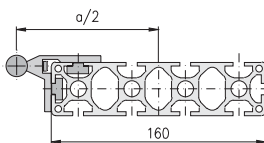

Descr.	Base profile		Shaft		Moment of i.			G	Article-No.
	Dim.	L1	L2	Ø	a/2	lx	ly		
LWF-1	80x160	H	H	12	102	330	1,227	12.7	4.119.00.080160.124HH12.12...
LWF-1	80x160	H	H	16	106	340	1,324	13.4	4.119.00.080160.124HH12.16...
LWF-1	80x160	H	H	20	112	362	1,527	14.7	4.119.00.080160.124HH12.20...
LWF-1	80x160	H	H	25	116	375	1,743	16.3	4.119.00.080160.124HH12.25...

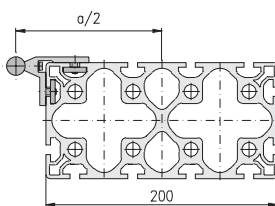

Descr.	Base profile		Shaft		Moment of i.			G	Article-No.
	Dim.	L1	L2	Ø	a/2	lx	ly		
LWF-1	100x200	H	H	12	122	858	3,044	19.7	4.119.00.100200.124HH12.12...
LWF-1	100x200	H	H	16	126	877	3,193	20.4	4.119.00.100200.124HH12.16...
LWF-1	100x200	H	H	20	132	919	3,519	21.7	4.119.00.100200.124HH12.20...
LWF-1	100x200	H	H	25	136	946	3,863	23.3	4.119.00.100200.124HH12.25...

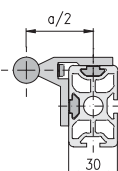

Descr.	Base profile		Shaft		Moment of i.			G	Article-No.
	Dim.	L1	L2	Ø	a/2	lx	ly		
LWF-1	30x50	V	H	12	37	32	26	4.1	4.119.00.030050.44VH12.12...
LWF-1	30x50	V	H	16	41	34	39	4.7	4.119.00.030050.44VH12.16...

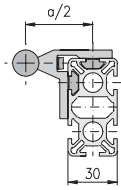

Descr.	Base profile Dim.	Shaft			Moment of i.			G kg/m	Article-No.
		L1	L2	Ø	a/2	lx	ly		
LWF-1	30×60	V	H	12	37	46	27	4.2	4.119.00.030060.64VH12.12...
LWF-1	30×60	V	H	16	41	49	40	4.8	4.119.00.030060.64VH12.16...

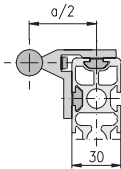

Descr.	Base profile Dim.	Shaft			Moment of i.			G kg/m	Article-No.
		L1	L2	Ø	a/2	lx	ly		
LWF-1	30×100	V	H	12	37	183	34	5.5	4.119.00.030100.84VH12.12...
LWF-1	30×100	V	H	16	41	193	49	6.1	4.119.00.030100.84VH12.16...

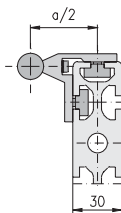

Descr.	Base profile Dim.	Shaft			Moment of i.			G kg/m	Article-No.
		L1	L2	Ø	a/2	lx	ly		
LWF-1	30×150	V	H	12	37	672	50	10.0	4.119.00.030150.84VH12.12...
LWF-1	30×150	V	H	16	41	707	68	10.6	4.119.00.030150.84VH12.16...

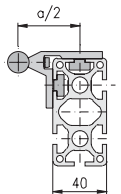

Descr.	Base profile Dim.	Shaft			Moment of i.			G kg/m	Article-No.
		L1	L2	Ø	a/2	lx	ly		
LWF-1	40×80	V	H	12	42	129	55	6.0	4.119.00.040080.65VH12.12...
LWF-1	40×80	V	H	16	46	136	74	6.7	4.119.00.040080.65VH12.16...
LWF-1	40×80	V	H	20	52	150	110	8.0	4.119.00.040080.65VH12.20...
LWF-1	40×80	V	H	25	56	156	153	9.6	4.119.00.040080.65VH12.25...

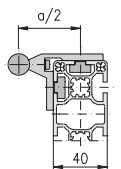

Descr.	Base profile Dim.	Shaft			Moment of i.			G kg/m	Article-No.
		L1	L2	Ø	a/2	lx	ly		
LWF-1	40×120 L	V	H	12	42	308	57	5.9	4.119.00.040120.84LVH12.12...
LWF-1	40×120 L	V	H	16	46	323	76	6.6	4.119.00.040120.84LVH12.16...
LWF-1	40×120 L	V	H	20	52	112	354	7.9	4.119.00.040120.84LVH12.20...
LWF-1	40×120 L	V	H	25	56	370	156	9.5	4.119.00.040120.84LVH12.25...

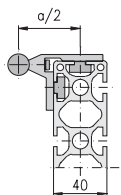

Descr.	Base profile Dim.	Shaft			Moment of i.			G kg/m	Article-No.
		L1	L2	Ø	a/2	lx	ly		
LWF-1	40×160 L	V	H	12	42	704	70	7.8	4.119.00.040160.104LVH12.12...
LWF-1	40×160 L	V	H	16	46	737	91	8.5	4.119.00.040160.104LVH12.16...
LWF-1	40×160 L	V	H	20	52	810	131	9.8	4.119.00.040160.104LVH12.20...
LWF-1	40×160 L	V	H	25	56	855	181	11.4	4.119.00.040160.104LVH12.25...

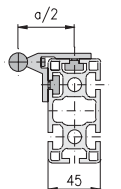

Descr.	Base profile Dim.	Shaft			Moment of i.			G kg/m	Article-No.
		L1	L2	Ø	a/2	lx	ly		
LWF-1	45×90	V	H	12	44.5	191	71	6.6	4.119.00.045090.64VH12.12...
LWF-1	45×90	V	H	16	48.5	200	92	7.3	4.119.00.045090.64VH12.16...
LWF-1	45×90	V	H	20	54.5	220	133	8.6	4.119.00.045090.64VH12.20...
LWF-1	45×90	V	H	25	58.5	229	183	10.2	4.119.00.045090.64VH12.25...

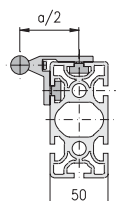

Descr.	Base profile Dim.	Shaft			Moment of i.			G kg/m	Article-No.
		L1	L2	Ø	a/2	lx	ly		
LWF-1	50×100	V	H	12	47	283	100	8.1	4.119.00.050100.65VH12.12...
LWF-1	50×100	V	H	16	51	297	124	8.8	4.119.00.050100.65VH12.16...
LWF-1	50×100	V	H	20	57	325	172	10.1	4.119.00.050100.65VH12.20...
LWF-1	50×100	V	H	25	61	340	230	11.7	4.119.00.050100.65VH12.25...

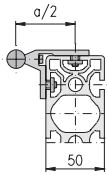

Descr.	Base profile		Shaft		Moment of i.			G	Article-No.
	Dim.	L1	L2	Ø	a/2	lx	ly		
LWF-1	50×150	V	H	12	47	833	128	10.3	4.119.00.050150.85VH12.12...
LWF-1	50×150	V	H	16	51	868	154	11.0	4.119.00.050150.85VH12.16...
LWF-1	50×150	V	H	20	57	945	206	12.3	4.119.00.050150.85VH12.20...
LWF-1	50×150	V	H	25	61	995	271	13.9	4.119.00.050150.85VH12.25...

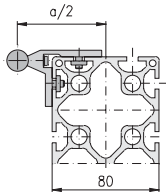

Descr.	Base profile		Shaft		Moment of i.			G	Article-No.
	Dim.	L1	L2	Ø	a/2	lx	ly		
LWF-1	80×160	V	H	12	62	1,160	366	12.7	4.119.00.080160.124VH12.12...
LWF-1	80×160	V	H	16	66	1,202	409	13.4	4.119.00.080160.124VH12.16...
LWF-1	80×160	V	H	20	72	1,299	493	14.7	4.119.00.080160.124VH12.20...
LWF-1	80×160	V	H	25	76	1,365	594	16.3	4.119.00.080160.124VH12.25...

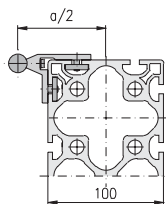

Descr.	Base profile		Shaft		Moment of i.			G	Article-No.
	Dim.	L1	L2	Ø	a/2	lx	ly		
LWF-1	100×200	V	H	12	72	2,958	904	19.7	4.119.00.100200.124VH12.12...
LWF-1	100×200	V	H	16	76	3,034	964	20.4	4.119.00.100200.124VH12.16...
LWF-1	100×200	V	H	20	82	3,218	1,087	21.7	4.119.00.100200.124VH12.20...
LWF-1	100×200	V	H	25	86	3,355	1,232	23.3	4.119.00.100200.124VH12.25...

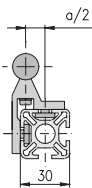

Descr.	Base profile		Shaft		Moment of i.			G	Article-No.
	Dim.	L1	L2	Ø	a/2	lx	ly		
LWF-1	30×30	N	V	12	11	20	9	3.0	4.119.00.030030.43NV12.12...
LWF-1	30×30	N	V	16	12	31	9	3.7	4.119.00.030030.43NV12.16...

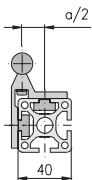

Descr.	Base profile		Shaft		Moment of i.			G	Article-No.
	Dim.	L1	L2	Ø	a/2	lx	ly		
LWF-1	40×40	N	V	12	16	40	24	4.2	4.119.00.040040.43NV12.12...
LWF-1	40×40	N	V	16	17	56	25	4.9	4.119.00.040040.43NV12.16...
LWF-1	40×40	N	V	20	16	85	29	6.2	4.119.00.040040.43NV12.20...
LWF-1	40×40	N	V	25	14	119	30	7.8	4.119.00.040040.43NV12.25...

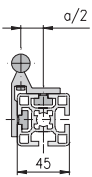

Descr.	Base profile		Shaft		Moment of i.			G	Article-No.
	Dim.	L1	L2	Ø	a/2	lx	ly		
LWF-1	45×45	N	V	12	18.5	50	32	4.5	4.119.00.045045.43NV12.12...
LWF-1	45×45	N	V	16	19.5	68	34	5.2	4.119.00.045045.43NV12.16...
LWF-1	45×45	N	V	20	18.5	100	37	6.5	4.119.00.045045.43NV12.20...
LWF-1	45×45	N	V	25	16.5	138	39	8.1	4.119.00.045045.43NV12.25...

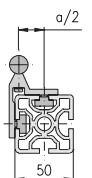

Descr.	Base profile		Shaft		Moment of i.			G	Article-No.
	Dim.	L1	L2	Ø	a/2	lx	ly		
LWF-1	50×50	N	V	12	21	67	46	5.3	4.119.00.050050.43NV12.12...
LWF-1	50×50	N	V	16	22	88	49	6.0	4.119.00.050050.43NV12.16...
LWF-1	50×50	N	V	20	21	126	54	7.3	4.119.00.050050.43NV12.20...
LWF-1	50×50	N	V	25	19	172	56	8.9	4.119.00.050050.43NV12.25...

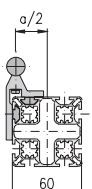

Descr.	Base profile		Shaft		Moment of i.			G	Article-No.	
	Dim.	L1	L2	Ø	a/2	lx	ly			kg/m
LWF-1	60×60	L	N	V	12	26	87	64	4.7	4.119.00.060060.83LNV12.12...
LWF-1	60×60	L	N	V	16	27	108	64	5.5	4.119.00.060060.83LNV12.16...

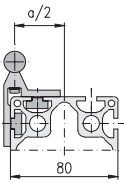

Descr.	Base profile Dim.	Shaft		Moment of i.			G kg/m	Article-No.
		L1	L2 Ø	a/2	lx	ly		
LWF-1	80×80	N	V 12	36	239	205	8.1	4.119.00.080080.83NV12.12...
LWF-1	80×80	N	V 16	37	272	209	8.8	4.119.00.080080.83NV12.16...
LWF-1	80×80	N	V 20	36	350	232	10.1	4.119.00.080080.83NV12.20...
LWF-1	80×80	N	V 25	34	435	241	11.7	4.119.00.080080.83NV12.25...

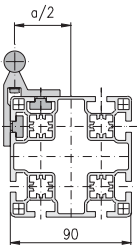

Descr.	Base profile Dim.	Shaft		Moment of i.			G kg/m	Article-No.
		L1	L2 Ø	a/2	lx	ly		
LWF-1	90×90 L	N	V 12	41	290	252	7.5	4.119.00.090090.83LNV12.12...
LWF-1	90×90 L	N	V 16	41	350	280	8.2	4.119.00.090090.83LNV12.16...
LWF-1	90×90 L	N	V 20	41	432	302	9.5	4.119.00.090090.83LNV12.20...
LWF-1	90×90 L	N	V 25	39	524	316	11.1	4.119.00.090090.83LNV12.25...

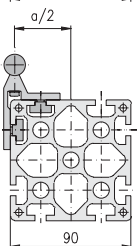

Descr.	Base profile Dim.	Shaft		Moment of i.			G kg/m	Article-No.
		L1	L2 Ø	a/2	lx	ly		
LWF-1	90×90	N	V 12	41	386	346	11.7	4.119.00.090090.83NV12.12...
LWF-1	90×90	N	V 16	41	437	360	12.4	4.119.00.090090.83NV12.16...
LWF-1	90×90	N	V 20	41	527	386	13.7	4.119.00.090090.83NV12.20...
LWF-1	90×90	N	V 25	39	637	402	15.3	4.119.00.090090.83NV12.25...

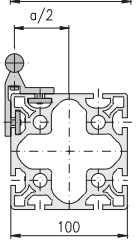

Descr.	Base profile Dim.	Shaft		Moment of i.			G kg/m	Article-No.
		L1	L2 Ø	a/2	lx	ly		
LWF-1	100×100	N	V 12	46	523	479	11.9	4.119.00.100100.83NV12.12...
LWF-1	100×100	N	V 16	47	577	496	12.6	4.119.00.100100.83NV12.16...
LWF-1	100×100	N	V 20	46	684	531	13.9	4.119.00.100100.83NV12.20...
LWF-1	100×100	N	V 25	44	808	552	15.5	4.119.00.100100.83NV12.25...

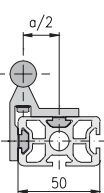

Descr.	Base profile Dim.	Shaft		Moment of i.			G kg/m	Article-No.
		L1	L2 Ø	a/2	lx	ly		
LWF-1	30×50	H	V 12	21	26	32	4.1	4.119.00.030050.44HV12.12...
LWF-1	30×50	H	V 16	22	39	34	4.7	4.119.00.030050.44HV12.16...

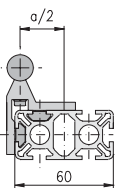

Descr.	Base profile Dim.	Shaft		Moment of i.			G kg/m	Article-No.
		L1	L2 Ø	a/2	lx	ly		
LWF-1	30×60	H	V 12	26	27	46	4.2	4.119.00.030060.64HV12.12...
LWF-1	30×60	H	V 16	27	40	49	4.8	4.119.00.030060.64HV12.16...

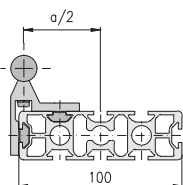

Descr.	Base profile Dim.	Shaft		Moment of i.			G kg/m	Article-No.
		L1	L2 Ø	a/2	lx	ly		
LWF-1	30×100	H	V 12	46	34	183	5.5	4.119.00.030100.84HV12.12...
LWF-1	30×100	H	V 16	47	49	193	6.1	4.119.00.030100.84HV12.16...

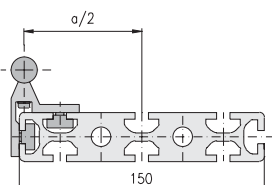

Descr.	Base profile Dim.	Shaft		Moment of i.			G kg/m	Article-No.
		L1	L2 Ø	a/2	lx	ly		
LWF-1	30×150	H	V 12	71	50	672	10.0	4.119.00.030150.84HV12.12...
LWF-1	30×150	H	V 16	72	68	707	10.6	4.119.00.030150.84HV12.16...

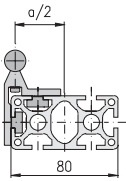

Descr.	Base profile Dim.	Shaft		Moment of i.			G kg/m	Article-No.
		L1	L2 Ø	a/2	lx	ly		
LWF-1	40x80	H	V 12	36	55	129	6.0	4.119.00.040080.65HV12.12...
LWF-1	40x80	H	V 16	37	74	136	6.7	4.119.00.040080.65HV12.16...
LWF-1	40x80	H	V 20	36	110	150	8.0	4.119.00.040080.65HV12.20...
LWF-1	40x80	H	V 25	34	153	156	9.6	4.119.00.040080.65HV12.25...

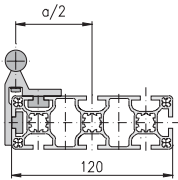

Descr.	Base profile Dim.	Shaft		Moment of i.			G kg/m	Article-No.
		L1	L2 Ø	a/2	lx	ly		
LWF-1	40x120 L	H	V 12	56	57	308	5.9	4.119.00.040120.84LHV12.12...
LWF-1	40x120 L	H	V 16	57	76	323	6.6	4.119.00.040120.84LHV12.16...
LWF-1	40x120 L	H	V 20	56	354	112	7.9	4.119.00.040120.84LHV12.20...
LWF-1	40x120 L	H	V 25	54	156	370	9.5	4.119.00.040120.84LHV12.25...

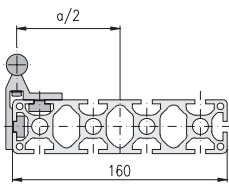

Descr.	Base profile Dim.	Shaft		Moment of i.			G kg/m	Article-No.
		L1	L2 Ø	a/2	lx	ly		
LWF-1	40x160 L	H	V 12	76	70	704	7.8	4.119.00.040160.104LHV12.12...
LWF-1	40x160 L	H	V 16	77	91	737	8.5	4.119.00.040160.104LHV12.16...
LWF-1	40x160 L	H	V 20	76	131	810	9.8	4.119.00.040160.104LHV12.20...
LWF-1	40x160 L	H	V 25	74	181	855	11.4	4.119.00.040160.104LHV12.25...

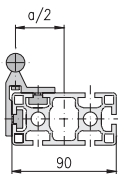

Descr.	Base profile Dim.	Shaft		Moment of i.			G kg/m	Article-No.
		L1	L2 Ø	a/2	lx	ly		
LWF-1	45x90	H	V 12	41	71	191	6.6	4.119.00.045090.64HV12.12...
LWF-1	45x90	H	V 16	42	92	200	7.3	4.119.00.045090.64HV12.16...
LWF-1	45x90	H	V 20	41	133	220	8.6	4.119.00.045090.64HV12.20...
LWF-1	45x90	H	V 25	39	183	229	10.2	4.119.00.045090.64HV12.25...

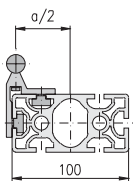

Descr.	Base profile Dim.	Shaft		Moment of i.			G kg/m	Article-No.
		L1	L2 Ø	a/2	lx	ly		
LWF-1	50x100	H	V 12	46	100	283	8.1	4.119.00.050100.65HV12.12...
LWF-1	50x100	H	V 16	47	124	297	8.8	4.119.00.050100.65HV12.16...
LWF-1	50x100	H	V 20	46	172	325	10.1	4.119.00.050100.65HV12.20...
LWF-1	50x100	H	V 25	44	230	340	11.7	4.119.00.050100.65HV12.25...

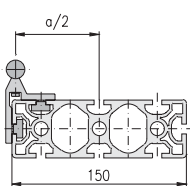

Descr.	Base profile Dim.	Shaft		Moment of i.			G kg/m	Article-No.
		L1	L2 Ø	a/2	lx	ly		
LWF-1	50x150	H	V 12	71	128	833	10.3	4.119.00.050150.85HV12.12...
LWF-1	50x150	H	V 16	72	154	868	11.0	4.119.00.050150.85HV12.16...
LWF-1	50x150	H	V 20	71	206	945	12.3	4.119.00.050150.85HV12.20...
LWF-1	50x150	H	V 25	69	271	995	13.9	4.119.00.050150.85HV12.25...

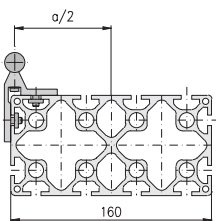

Descr.	Base profile Dim.	Shaft		Moment of i.			G kg/m	Article-No.
		L1	L2 Ø	a/2	lx	ly		
LWF-1	80x160	H	V 12	76	366	1,160	12.7	4.119.00.080160.124HV12.12...
LWF-1	80x160	H	V 16	77	409	1,202	13.4	4.119.00.080160.124HV12.16...
LWF-1	80x160	H	V 20	76	493	1,299	14.7	4.119.00.080160.124HV12.20...
LWF-1	80x160	H	V 25	74	594	1,365	16.3	4.119.00.080160.124HV12.25...

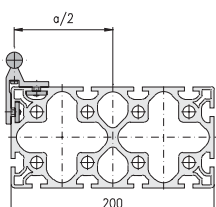

Descr.	Base profile Dim.	Shaft		Moment of i.			G kg/m	Article-No.
		L1	L2 Ø	a/2	lx	ly		
LWF-1	100x200	H	V 12	96	904	2,958	19.7	4.119.00.100200.124HV12.12...
LWF-1	100x200	H	V 16	97	964	3,034	20.4	4.119.00.100200.124HV12.16...
LWF-1	100x200	H	V 20	96	1,087	3,218	21.7	4.119.00.100200.124HV12.20...
LWF-1	100x200	H	V 25	94	1,232	3,355	23.3	4.119.00.100200.124HV12.25...

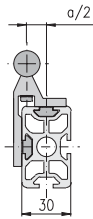

Descr.	Base profile Dim.	Shaft			Moment of i.			G kg/m	Article-No.
		L1	L2	Ø	a/2	lx	ly		
LWF-1	30×50	V	V	12	11	51	13	4.1	4.119.00.030050.44VV12.12...
LWF-1	30×50	V	V	16	12	69	14	4.7	4.119.00.030050.44VV12.16...

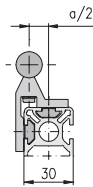

Descr.	Base profile Dim.	Shaft			Moment of i.			G kg/m	Article-No.
		L1	L2	Ø	a/2	lx	ly		
LWF-1	30×60	V	V	12	11	68	13	4.2	4.119.00.030060.64VV12.12...
LWF-1	30×60	V	V	16	12	87	14	4.8	4.119.00.030060.64VV12.16...

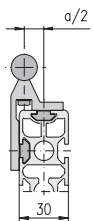

Descr.	Base profile Dim.	Shaft			Moment of i.			G kg/m	Article-No.
		L1	L2	Ø	a/2	lx	ly		
LWF-1	30×100	V	V	12	11	220	19	5.5	4.119.00.030100.84VV12.12...
LWF-1	30×100	V	V	16	12	260	20	6.1	4.119.00.030100.84VV12.16...

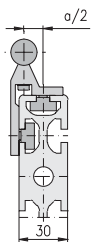

Descr.	Base profile Dim.	Shaft			Moment of i.			G kg/m	Article-No.
		L1	L2	Ø	a/2	lx	ly		
LWF-1	30×150	V	V	12	11	733	33	10.0	4.119.00.030150.84VV12.12...
LWF-1	30×150	V	V	16	12	819	34	10.6	4.119.00.030150.84VV12.16...

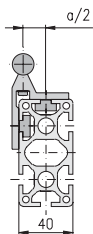

Descr.	Base profile Dim.	Shaft			Moment of i.			G kg/m	Article-No.
		L1	L2	Ø	a/2	lx	ly		
LWF-1	40×80	V	V	12	16	160	36	6.0	4.119.00.040080.65VV12.12...
LWF-1	40×80	V	V	16	17	193	38	6.7	4.119.00.040080.65VV12.16...
LWF-1	40×80	V	V	20	16	252	42	8.0	4.119.00.040080.65VV12.20...
LWF-1	40×80	V	V	25	14	320	44	9.6	4.119.00.040080.65VV12.25...

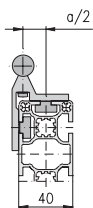

Descr.	Base profile Dim.	Shaft			Moment of i.			G kg/m	Article-No.
		L1	L2	Ø	a/2	lx	ly		
LWF-1	40×120 L	V	V	12	16	351	39	5.9	4.119.00.040120.84LVV12.12...
LWF-1	40×120 L	V	V	16	17	400	41	6.6	4.119.00.040120.84LVV12.16...
LWF-1	40×120 L	V	V	20	16	491	45	7.9	4.119.00.040120.84LVV12.20...
LWF-1	40×120 L	V	V	25	14	589	46	9.5	4.119.00.040120.84LVV12.25...

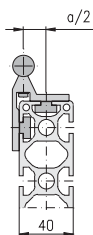

Descr.	Base profile Dim.	Shaft			Moment of i.			G kg/m	Article-No.
		L1	L2	Ø	a/2	lx	ly		
LWF-1	40×160 L	V	V	12	16	764	50	7.8	4.119.00.040160.104LVV12.12...
LWF-1	40×160 L	V	V	16	17	846	52	8.5	4.119.00.040160.104LVV12.16...
LWF-1	40×160 L	V	V	20	16	1,007	57	9.8	4.119.00.040160.104LVV12.20...
LWF-1	40×160 L	V	V	25	14	1,174	58	11.4	4.119.00.040160.104LVV12.25...

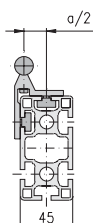

Descr.	Base profile Dim.	Shaft			Moment of i.			G kg/m	Article-No.
		L1	L2	Ø	a/2	lx	ly		
LWF-1	45×90	V	V	12	18.5	226	50	6.6	4.119.00.045090.64VV12.12...
LWF-1	45×90	V	V	16	18.5	268	53	7.3	4.119.00.045090.64VV12.16...
LWF-1	45×90	V	V	20	18.5	337	58	8.6	4.119.00.045090.64VV12.20...
LWF-1	45×90	V	V	25	16.5	420	60	10.2	4.119.00.045090.64VV12.25...

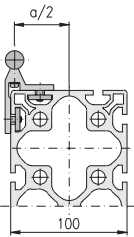
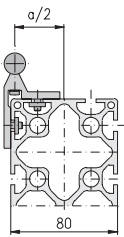
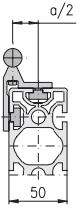
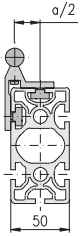

Descr.	Base profile		Shaft		Moment of i.			G	Article-No.
	Dim.	L1	L2	Ø	a/2	I _x	I _y		
LWF-1	50×100	V	V	12	21	324	76	8.1	4.119.00.050100.65VV12.12...
LWF-1	50×100	V	V	16	22	371	80	8.8	4.119.00.050100.65VV12.16...
LWF-1	50×100	V	V	20	21	462	87	10.1	4.119.00.050100.65VV12.20...
LWF-1	50×100	V	V	25	19	565	89	11.7	4.119.00.050100.65VV12.25...

Descr.	Base profile		Shaft		Moment of i.			G	Article-No.
	Dim.	L1	L2	Ø	a/2	I _x	I _y		
LWF-1	50×150	V	V	12	21	894	103	10.3	4.119.00.050150.85VV12.12...
LWF-1	50×150	V	V	16	22	979	107	11.0	4.119.00.050150.85VV12.16...
LWF-1	50×150	V	V	20	21	1,151	115	12.3	4.119.00.050150.85VV12.20...
LWF-1	50×150	V	V	25	19	1,334	118	13.9	4.119.00.050150.85VV12.25...

Descr.	Base profile		Shaft		Moment of i.			G	Article-No.
	Dim.	L1	L2	Ø	a/2	I _x	I _y		
LWF-1	80×160	V	V	12	36	1,227	330	12.7	4.119.00.080160.124VV12.12...
LWF-1	80×160	V	V	16	37	1,324	340	13.4	4.119.00.080160.124VV12.16...
LWF-1	80×160	V	V	20	36	1,527	362	14.7	4.119.00.080160.124VV12.20...
LWF-1	80×160	V	V	25	34	1,743	375	16.3	4.119.00.080160.124VV12.25...

Descr.	Base profile		Shaft		Moment of i.			G	Article-No.
	Dim.	L1	L2	Ø	a/2	I _x	I _y		
LWF-1	100×200	V	V	12	46	3,044	858	19.7	4.119.00.100200.124VV12.12...
LWF-1	100×200	V	V	16	47	3,193	877	20.4	4.119.00.100200.124VV12.16...
LWF-1	100×200	V	V	20	46	3,519	919	21.7	4.119.00.100200.124VV12.20...
LWF-1	100×200	V	V	25	44	3,863	946	23.3	4.119.00.100200.124VV12.25...

LWF-2 complete (Linear shaft guidance, double sided)

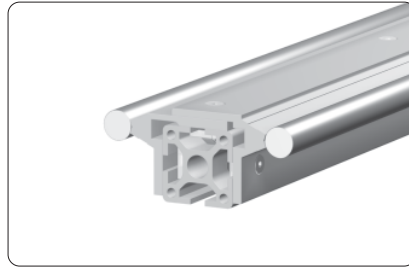

Legend

- Descr. = description
- Dim. = dimension
- L1 = orientation of base profile
- L2 = orientation of linear shaft guidance
- Ø = diameter of shaft in mm
- a = axle distance in mm
- I_x, I_y = moment of inertia in cm⁴
- G = weight in kg/m

Orientation

- N = neutral
- H = horizontal
- V = vertical

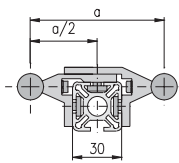

Descr.	Base profile	Shaft	Moment of i.			G	Article-No.
Dim.	L1	L2 Ø	a	I _x	I _y	kg/m	
LWF-2	30x30	N H 12	74	14	60	5.0	4.119.00.030030.43NH22.12...
LWF-2	30x30	N H 16	82	16	104	6.5	4.119.00.030030.43NH22.16...

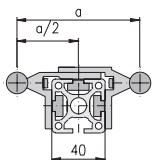

Descr.	Base profile	Shaft	Moment of i.			G	Article-No.
Dim.	L1	L2 Ø	a	I _x	I _y	kg/m	
LWF-2	40x40	N H 12	84	34	95	6.3	4.119.00.040040.43NH22.12...
LWF-2	40x40	N H 16	92	37	149	7.8	4.119.00.040040.43NH22.16...
LWF-2	40x40	N H 20	104	44	263	10.3	4.119.00.040040.43NH22.20...
LWF-2	40x40	N H 25	112	47	421	13.5	4.119.00.040040.43NH22.25...

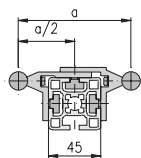

Descr.	Base profile	Shaft	Moment of i.			G	Article-No.
Dim.	L1	L2 Ø	a	I _x	I _y	kg/m	
LWF-2	45x45	N H 12	89	43	113	6.6	4.119.00.045045.43NH22.12...
LWF-2	45x45	N H 16	97	47	173	8.1	4.119.00.045045.43NH22.16...
LWF-2	45x45	N H 20	109	54	299	10.6	4.119.00.045045.43NH22.20...
LWF-2	45x45	N H 25	117	56	470	13.8	4.119.00.045045.43NH22.25...

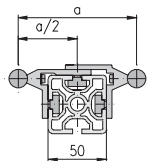

Descr.	Base profile	Shaft	Moment of i.			G	Article-No.
Dim.	L1	L2 Ø	a	I _x	I _y	kg/m	
LWF-2	50x50	N H 12	94	60	138	7.4	4.119.00.050050.43NH22.12...
LWF-2	50x50	N H 16	102	65	203	8.9	4.119.00.050050.43NH22.16...
LWF-2	50x50	N H 20	114	74	342	11.4	4.119.00.050050.43NH22.20...
LWF-2	50x50	N H 25	122	77	526	14.6	4.119.00.050050.43NH22.25...

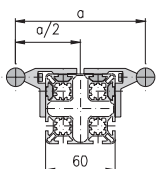

Descr.	Base profile	Shaft	Moment of i.			G	Article-No.
Dim.	L1	L2 Ø	a	I _x	I _y	kg/m	
LWF-2	60x60 L	N H 12	104	76	182	6.7	4.119.00.060060.83LNH22.12...
LWF-2	60x60 L	N H 16	112	80	258	8.1	4.119.00.060060.83LNH22.16...

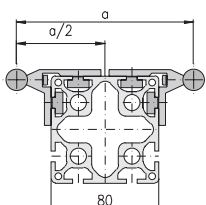

Descr.	Base profile	Shaft	Moment of i.			G	Article-No.
Dim.	L1	L2 Ø	a	I _x	I _y	kg/m	
LWF-2	80x80	N H 12	124	246	377	10.3	4.119.00.080080.83NH22.12...
LWF-2	80x80	N H 16	132	253	475	11.7	4.119.00.080080.83NH22.16...
LWF-2	80x80	N H 20	144	283	703	14.2	4.119.00.080080.83NH22.20...
LWF-2	80x80	N H 25	152	293	984	17.4	4.119.00.080080.83NH22.25...

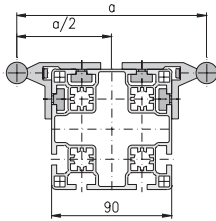

Descr.	Base profile		Shaft		Moment of i.			G	Article-No.	
	Dim.	L1	L2	Ø	a	lx	ly			kg/m
LWF-2	90×90	L	N	H	12	134	294	455	9.7	4.119.00.090090.83LNH22.12...
LWF-2	90×90	L	N	H	16	142	309	585	11.1	4.119.00.090090.83LNH22.16...
LWF-2	90×90	L	N	H	20	154	335	829	17.8	4.119.00.090090.83LNH22.20...
LWF-2	90×90	L	N	H	25	162	346	1,148	16.8	4.119.00.090090.83LNH22.25...

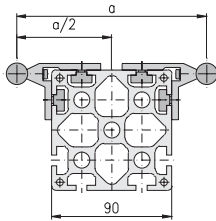

Descr.	Base profile		Shaft		Moment of i.			G	Article-No.	
	Dim.	L1	L2	Ø	a	lx	ly			kg/m
LWF-2	90×90		N	H	12	134	408	547	13.9	4.119.00.090090.83NH22.12...
LWF-2	90×90		N	H	16	142	430	677	15.3	4.119.00.090090.83NH22.16...
LWF-2	90×90		N	H	20	154	468	921	17.8	4.119.00.090090.83NH22.20...
LWF-2	90×90		N	H	25	162	488	1,240	21.0	4.119.00.090090.83NH22.25...

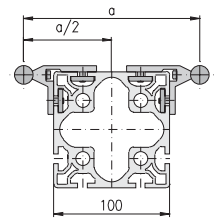

Descr.	Base profile		Shaft		Moment of i.			G	Article-No.	
	Dim.	L1	L2	Ø	a	lx	ly			kg/m
LWF-2	100×100		N	H	12	144	558	717	14.1	4.119.00.100100.83NH22.12...
LWF-2	100×100		N	H	16	152	583	850	15.5	4.119.00.100100.83NH22.16...
LWF-2	100×100		N	H	20	164	635	1,143	18.0	4.119.00.100100.83NH22.20...
LWF-2	100×100		N	H	25	172	661	1,501	21.2	4.119.00.100100.83NH22.25...

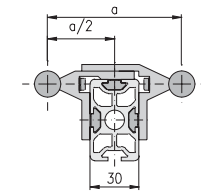

Descr.	Base profile		Shaft		Moment of i.			G	Article-No.	
	Dim.	L1	L2	Ø	a	lx	ly			kg/m
LWF-2	30×50		H	H	12	94	19	120	6.0	4.119.00.030050.44HH22.12...
LWF-2	30×50		H	H	16	102	21	186	7.5	4.119.00.030050.44HH22.16...

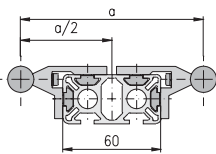

Descr.	Base profile		Shaft		Moment of i.			G	Article-No.	
	Dim.	L1	L2	Ø	a	lx	ly			kg/m
LWF-2	30×60		H	H	12	104	17	158	5.9	4.119.00.030060.64HH22.12...
LWF-2	30×60		H	H	16	112	18	235	7.3	4.119.00.030060.64HH22.16...

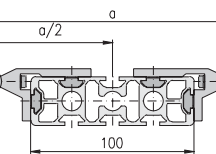

Descr.	Base profile		Shaft		Moment of i.			G	Article-No.	
	Dim.	L1	L2	Ø	a	lx	ly			kg/m
LWF-2	30×100		H	H	12	144	24	421	7.5	4.119.00.030100.84HH22.12...
LWF-2	30×100		H	H	16	152	26	554	8.9	4.119.00.030100.84HH22.16...

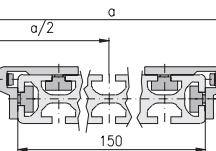

Descr.	Base profile		Shaft		Moment of i.			G	Article-No.	
	Dim.	L1	L2	Ø	a	lx	ly			kg/m
LWF-2	30×150		H	H	12	194	40	1,115	12.0	4.119.00.030150.84HH22.12...
LWF-2	30×150		H	H	16	202	42	1,341	13.4	4.119.00.030150.84HH22.16...

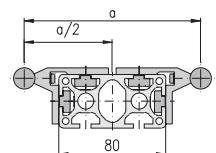

Descr.	Base profile		Shaft		Moment of i.			G	Article-No.	
	Dim.	L1	L2	Ø	a	lx	ly			kg/m
LWF-2	40×80		H	H	12	124	47	308	8.2	4.119.00.040080.65HH22.12...
LWF-2	40×80		H	H	16	132	49	420	9.6	4.119.00.040080.65HH22.16...
LWF-2	40×80		H	H	20	144	56	634	12.1	4.119.00.040080.65HH22.20...
LWF-2	40×80		H	H	25	152	58	915	15.3	4.119.00.040080.65HH22.25...

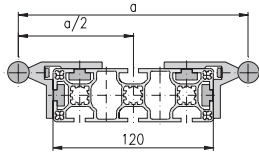

Descr.	Base profile		Shaft		Moment of i.			G	Article-No.
	Dim.	L1	L2	Ø	lx	ly	kg/m		
LWF-2	40x120	L H	H	12	164	49	659	8.1	4.119.00.040120.84LHH22.12...
LWF-2	40x120	L H	H	16	172	52	826	9.5	4.119.00.040120.84LHH22.16...
LWF-2	40x120	L H	H	20	184	59	1,199	12.0	4.119.00.040120.84LHH22.20...
LWF-2	40x120	L H	H	25	192	61	1,643	15.2	4.119.00.040120.84LHH22.25...

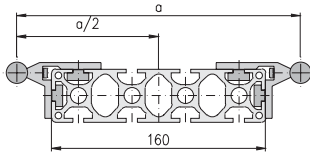

Descr.	Base profile		Shaft		Moment of i.			G	Article-No.
	Dim.	L1	L2	Ø	lx	ly	kg/m		
LWF-2	40x160	L H	H	12	204	62	1,263	10.0	4.119.00.040160.104LHH22.12...
LWF-2	40x160	L H	H	16	212	65	1,510	11.4	4.119.00.040160.104LHH22.16...
LWF-2	40x160	L H	H	20	224	73	2,070	13.9	4.119.00.040160.104LHH22.20...
LWF-2	40x160	L H	H	25	232	75	2,716	17.1	4.119.00.040160.104LHH22.25...

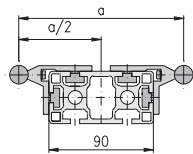

Descr.	Base profile		Shaft		Moment of i.			G	Article-No.
	Dim.	L1	L2	Ø	lx	ly	kg/m		
LWF-2	45x90	H	H	12	134	63	403	8.8	4.119.00.045090.64HH22.12...
LWF-2	45x90	H	H	16	142	67	532	10.2	4.119.00.045090.64HH22.16...
LWF-2	45x90	H	H	20	154	75	777	12.7	4.119.00.045090.64HH22.20...
LWF-2	45x90	H	H	25	162	77	1,095	15.9	4.119.00.045090.64HH22.25...

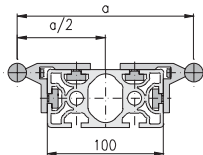

Descr.	Base profile		Shaft		Moment of i.			G	Article-No.
	Dim.	L1	L2	Ø	lx	ly	kg/m		
LWF-2	50x100	H	H	12	144	93	530	10.3	4.119.00.050100.65HH22.12...
LWF-2	50x100	H	H	16	152	98	663	11.7	4.119.00.050100.65HH22.16...
LWF-2	50x100	H	H	20	164	109	956	14.2	4.119.00.050100.65HH22.20...
LWF-2	50x100	H	H	25	172	112	1,314	17.4	4.119.00.050100.65HH22.25...

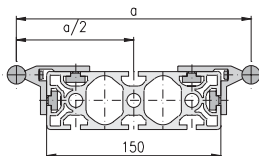

Descr.	Base profile		Shaft		Moment of i.			G	Article-No.
	Dim.	L1	L2	Ø	lx	ly	kg/m		
LWF-2	50x150	H	H	12	194	122	1,313	12.5	4.119.00.050150.85HH22.12...
LWF-2	50x150	H	H	16	202	129	1,539	13.9	4.119.00.050150.85HH22.16...
LWF-2	50x150	H	H	20	214	141	2,052	16.4	4.119.00.050150.85HH22.20...
LWF-2	50x150	H	H	25	222	144	2,640	19.6	4.119.00.050150.85HH22.25...

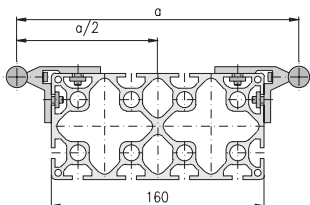

Descr.	Base profile		Shaft		Moment of i.			G	Article-No.
	Dim.	L1	L2	Ø	lx	ly	kg/m		
LWF-2	80x160	H	H	12	204	380	1,688	14.9	4.119.00.080160.124HH22.12...
LWF-2	80x160	H	H	16	212	397	1,936	16.3	4.119.00.080160.124HH22.16...
LWF-2	80x160	H	H	20	224	430	2,500	18.8	4.119.00.080160.124HH22.20...
LWF-2	80x160	H	H	25	232	446	3,142	22.0	4.119.00.080160.124HH22.25...

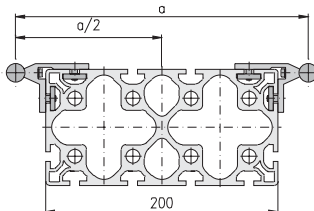

Descr.	Base profile		Shaft		Moment of i.			G	Article-No.
	Dim.	L1	L2	Ø	lx	ly	kg/m		
LWF-2	100x200	H	H	12	244	953	3,717	21.9	4.119.00.100200.124HH22.12...
LWF-2	100x200	H	H	16	252	985	4,060	23.3	4.119.00.100200.124HH22.16...
LWF-2	100x200	H	H	20	264	1,055	4,858	25.8	4.119.00.100200.124HH22.20...
LWF-2	100x200	H	H	25	272	1,096	5,733	29.0	4.119.00.100200.124HH22.25...

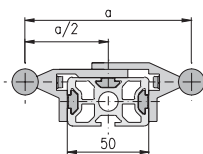

Descr.	Base profile		Shaft		Moment of i.			G	Article-No.
	Dim.	L1	L2	Ø	lx	ly	kg/m		
LWF-2	30x50	V	H	12	74	44	66	6.1	4.119.00.030050.44VH22.12...
LWF-2	30x50	V	H	16	82	48	109	7.6	4.119.00.030050.44VH22.16...

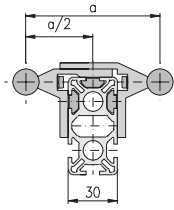

Descr.	Base profile		Shaft		Moment of i.			G	Article-No.
	Dim.	L1	L2	Ø	lx	ly	kg/m		
LWF-2	30x60	V	H	12	74	62	67	6.2	4.119.00.030060.64VH22.12...
LWF-2	30x60	V	H	16	82	67	110	7.7	4.119.00.030060.64VH22.16...

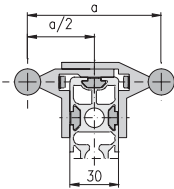

Descr.	Base profile		Shaft		Moment of i.			G	Article-No.
	Dim.	L1	L2	Ø	lx	ly	kg/m		
LWF-2	30x100	V	H	12	74	229	70	7.5	4.119.00.030100.84VH22.12...
LWF-2	30x100	V	H	16	82	247	114	9.0	4.119.00.030100.84VH22.16...

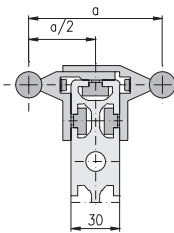

Descr.	Base profile		Shaft		Moment of i.			G	Article-No.
	Dim.	L1	L2	Ø	lx	ly	kg/m		
LWF-2	30x150	V	H	12	74	837	83	12.0	4.119.00.030150.84VH22.12...
LWF-2	30x150	V	H	16	82	903	127	13.5	4.119.00.030150.84VH22.16...

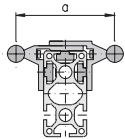

Descr.	Base profile		Shaft		Moment of i.			G	Article-No.
	Dim.	L1	L2	Ø	lx	ly	kg/m		
LWF-2	40x80	V	H	12	84	160	105	8.1	4.119.00.040080.65VH22.12...
LWF-2	40x80	V	H	16	92	172	159	9.6	4.119.00.040080.65VH22.16...
LWF-2	40x80	V	H	20	104	191	274	12.1	4.119.00.040080.65VH22.20...
LWF-2	40x80	V	H	25	112	196	4,317	15.3	4.119.00.040080.65VH22.25...

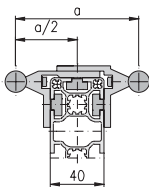

Descr.	Base profile		Shaft		Moment of i.			G	Article-No.
	Dim.	L1	L2	Ø	lx	ly	kg/m		
LWF-2	40x120 L	V	H	12	84	374	108	8.0	4.119.00.040120.84LVH22.12...
LWF-2	40x120 L	V	H	16	92	399	162	9.5	4.119.00.040120.84LVH22.16...
LWF-2	40x120 L	V	H	20	104	436	277	12.0	4.119.00.040120.84LVH22.20...
LWF-2	40x120 L	V	H	25	112	450	434	15.2	4.119.00.040120.84LVH22.25...

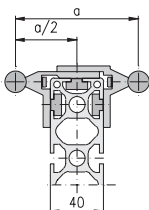

Descr.	Base profile		Shaft		Moment of i.			G	Article-No.
	Dim.	L1	L2	Ø	lx	ly	kg/m		
LWF-2	40x160 L	V	H	12	84	857	118	9.9	4.119.00.040160.104LVH22.12...
LWF-2	40x160 L	V	H	16	92	915	172	11.4	4.119.00.040160.104LVH22.16...
LWF-2	40x160 L	V	H	20	104	1,010	287	13.9	4.119.00.040160.104LVH22.20...
LWF-2	40x160 L	V	H	25	112	1,056	444	17.1	4.119.00.040160.104LVH22.25...

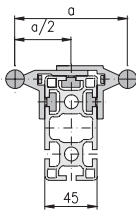

Descr.	Base profile		Shaft		Moment of i.			G	Article-No.
	Dim.	L1	L2	Ø	lx	ly	kg/m		
LWF-2	45x90	V	H	12	89	234	129	8.7	4.119.00.045090.64VH22.12...
LWF-2	45x90	V	H	16	97	251	189	10.2	4.119.00.045090.64VH22.16...
LWF-2	45x90	V	H	20	109	277	315	12.7	4.119.00.045090.64VH22.20...
LWF-2	45x90	V	H	25	117	286	486	15.9	4.119.00.045090.64VH22.25...

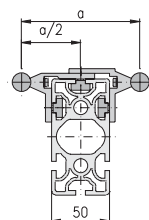

Descr.	Base profile		Shaft		Moment of i.			G	Article-No.
	Dim.	L1	L2	Ø	lx	ly	kg/m		
LWF-2	50x100	V	H	12	94	344	165	10.2	4.119.00.050100.65VH22.12...
LWF-2	50x100	V	H	16	102	369	231	11.7	4.119.00.050100.65VH22.16...
LWF-2	50x100	V	H	20	114	409	369	14.2	4.119.00.050100.65VH22.20...
LWF-2	50x100	V	H	25	122	424	554	17.4	4.119.00.050100.65VH22.25...

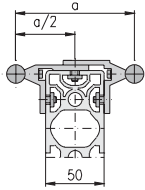

Descr.	Base profile Dim.	Shaft		Moment of i.			G kg/m	Article-No.
		L1	L2 Ø	a	I _x	I _y		
LWF-2	50x150 V	H	12	94	996	191	12.4	4.119.00.050150.65VH22.12...
LWF-2	50x150 V	H	16	102	1,062	257	13.9	4.119.00.050150.85VH22.16...
LWF-2	50x150 V	H	20	114	1,174	395	16.4	4.119.00.050150.85VH22.20...
LWF-2	50x150 V	H	25	122	1,232	580	19.6	4.119.00.050150.85VH22.25...

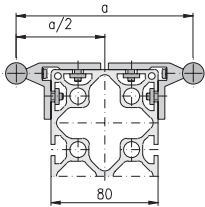

Descr.	Base profile Dim.	Shaft		Moment of i.			G kg/m	Article-No.
		L1	L2 Ø	a	I _x	I _y		
LWF-2	80x160 V	H	12	124	1,376	496	14.9	4.119.00.080160.124VH22.12...
LWF-2	80x160 V	H	16	132	1,441	599	16.3	4.119.00.080160.124VH22.16...
LWF-2	80x160 V	H	20	144	1,580	822	18.8	4.119.00.080160.124VH22.20...
LWF-2	80x160 V	H	25	152	1,666	1,104	22.0	4.119.00.080160.124VH22.25...

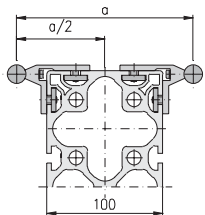

Descr.	Base profile Dim.	Shaft		Moment of i.			G kg/m	Article-No.
		L1	L2 Ø	a	I _x	I _y		
LWF-2	100x200 V	H	12	144	3,370	1,088	21.9	4.119.00.100200.124VH22.12...
LWF-2	100x200 V	H	16	152	3,499	1,221	23.3	4.119.00.100200.124VH22.16...
LWF-2	100x200 V	H	20	164	3,799	1,514	25.8	4.119.00.100200.124VH22.20...
LWF-2	100x200 V	H	25	172	4,007	1,872	29.0	4.119.00.100200.124VH22.25...

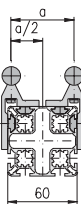

Descr.	Base profile Dim.	Shaft		Moment of i.			G kg/m	Article-No.	
		L1	L2 Ø	a	I _x	I _y			
LWF-2	60x60 L	N	V	12	52	117	112	6.9	4.119.00.060060.83LNV22.12...
LWF-2	60x60 L	N	V	16	54	152	135	8.3	4.119.00.060060.83LNV22.16...

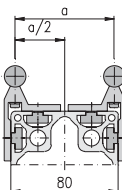

Descr.	Base profile Dim.	Shaft		Moment of i.			G kg/m	Article-No.
		L1	L2 Ø	a	I _x	I _y		
LWF-2	80x80 N	V	12	72	305	295	10.3	4.119.00.080080.83NV22.12...
LWF-2	80x80 N	V	16	74	359	318	11.7	4.119.00.080080.83NV22.16...
LWF-2	80x80 N	V	20	72	476	387	14.2	4.119.00.080080.83NV22.20...
LWF-2	80x80 N	V	25	68	601	431	17.4	4.119.00.080080.83NV22.25...

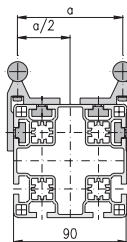

Descr.	Base profile Dim.	Shaft		Moment of i.			G kg/m	Article-No.	
		L1	L2 Ø	a	I _x	I _y			
LWF-2	90x90 L	N	V	12	82	356	364	9.7	4.119.00.090090.83LNV22.12...
LWF-2	90x90 L	N	V	16	84	424	405	11.1	4.119.00.090090.83LNV22.16...
LWF-2	90x90 L	N	V	20	82	533	484	13.6	4.119.00.090090.83LNV22.20...
LWF-2	90x90 L	N	V	25	78	659	542	16.8	4.119.00.090090.83LNV22.25...

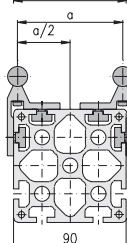

Descr.	Base profile Dim.	Shaft		Moment of i.			G kg/m	Article-No.
		L1	L2 Ø	a	I _x	I _y		
LWF-2	90x90 N	V	12	82	480	456	13.9	4.119.00.090090.83NV22.12...
LWF-2	90x90 N	V	16	84	565	496	15.3	4.119.00.090090.83NV22.16...
LWF-2	90x90 N	V	20	82	708	575	17.8	4.119.00.090090.83NV22.20...
LWF-2	90x90 N	V	25	78	876	634	21.0	4.119.00.090090.83NV22.25...

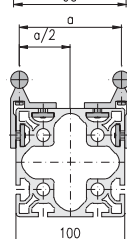

Descr.	Base profile Dim.	Shaft		Moment of i.			G kg/m	Article-No.
		L1	L2 Ø	a	I _x	I _y		
LWF-2	100x100 N	V	12	92	637	617	14.1	4.119.00.100100.83NV22.12...
LWF-2	100x100 N	V	16	94	727	661	15.5	4.119.00.100100.83NV22.16...
LWF-2	100x100 N	V	20	92	897	767	18.0	4.119.00.100100.83NV22.20...
LWF-2	100x100 N	V	25	88	1,087	842	21.2	4.119.00.100100.83NV22.25...

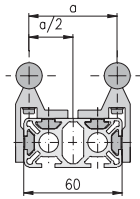

Descr.	Base profile Dim.	Shaft		Moment of i.			G kg/m	Article-No.
		L1	L2 Ø	a	lx	ly		
LWF-2	30x60	H	V 12	52	40	94	5.9	4.119.00.030060.64HV22.12...
LWF-2	30x60	H	V 16	54	61	109	7.3	4.119.00.030060.64HV22.16...

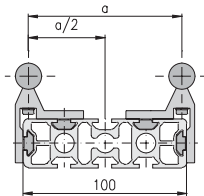

Descr.	Base profile Dim.	Shaft		Moment of i.			G kg/m	Article-No.
		L1	L2 Ø	a	lx	ly		
LWF-2	30x100	H	V 12	92	50	321	7.5	4.119.00.030100.84HV22.12...
LWF-2	30x100	H	V 16	94	75	37	8.9	4.119.00.030100.84HV22.16...

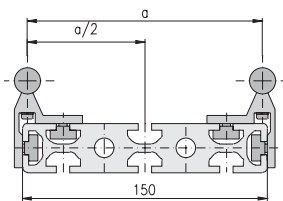

Descr.	Base profile Dim.	Shaft		Moment of i.			G kg/m	Article-No.
		L1	L2 Ø	a	lx	ly		
LWF-2	30x150	H	V 12	142	71	971	12.0	4.119.00.030150.84HV22.12...
LWF-2	30x150	H	V 16	144	102	1,072	13.4	4.119.00.030150.84HV22.16...

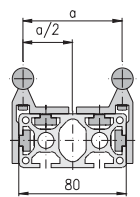

Descr.	Base profile Dim.	Shaft		Moment of i.			G kg/m	Article-No.
		L1	L2 Ø	a	lx	ly		
LWF-2	40x80	H	V 12	72	80	225	8.2	4.119.00.040080.65HV22.12...
LWF-2	40x80	H	V 16	74	110	253	9.6	4.119.00.040080.65HV22.16...
LWF-2	40x80	H	V 20	72	168	318	12.1	4.119.00.040080.65HV22.20...
LWF-2	40x80	H	V 25	68	234	362	15.3	4.119.00.040080.65HV22.25...

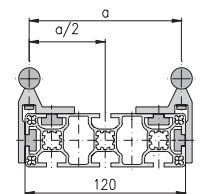

Descr.	Base profile Dim.	Shaft		Moment of i.			G kg/m	Article-No.
		L1	L2 Ø	a	lx	ly		
LWF-2	40x120 L	H	V 12	112	82	82	8.1	4.119.00.040120.84LHV22.12...
LWF-2	40x120 L	H	V 16	114	113	606	9.5	4.119.00.040120.84LHV22.16...
LWF-2	40x120 L	H	V 20	112	170	762	12.0	4.119.00.040120.84LHV22.20...
LWF-2	40x120 L	H	V 25	108	237	879	15.2	4.119.00.040120.84LHV22.25...

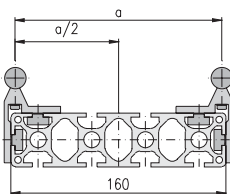

Descr.	Base profile Dim.	Shaft		Moment of i.			G kg/m	Article-No.
		L1	L2 Ø	a	lx	ly		
LWF-2	40x160 L	H	V 12	152	98	1,111	10.0	4.119.00.040160.104LHV22.12...
LWF-2	40x160 L	H	V 16	154	133	1,225	11.4	4.119.00.040160.104LHV22.16...
LWF-2	40x160 L	H	V 20	152	198	1,515	13.9	4.119.00.040160.104LHV22.20...
LWF-2	40x160 L	H	V 25	148	277	1,742	17.1	4.119.00.040160.104LHV22.25...

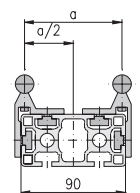

Descr.	Base profile Dim.	Shaft		Moment of i.			G kg/m	Article-No.
		L1	L2 Ø	a	lx	ly		
LWF-2	45x90	H	V 12	82	100	312	8.8	4.119.00.045090.64HV22.12...
LWF-2	45x90	H	V 16	84	135	347	10.2	4.119.00.045090.64HV22.16...
LWF-2	45x90	H	V 20	82	200	431	12.7	4.119.00.045090.64HV22.20...
LWF-2	45x90	H	V 25	78	276	489	15.9	4.119.00.045090.64HV22.25...

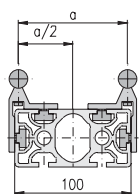

Descr.	Base profile Dim.	Shaft		Moment of i.			G kg/m	Article-No.
		L1	L2 Ø	a	lx	ly		
LWF-2	50x100	H	V 12	92	135	430	10.3	4.119.00.050100.65HV22.12...
LWF-2	50x100	H	V 16	94	176	474	11.7	4.119.00.050100.65HV22.16...
LWF-2	50x100	H	V 20	92	252	580	14.2	4.119.00.050100.65HV22.20...
LWF-2	50x100	H	V 25	88	341	655	17.4	4.119.00.050100.65HV22.25...

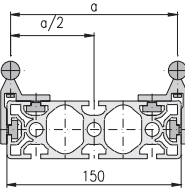

Descr.	Base profile		Shaft		Moment of i.			G	Article-No.
	Dim.	L1	L2	Ø	a	I _x	I _y		
LWF-2	50×150	H	V	12	142	167	1,170	12.5	4.119.00.050150.85HV22.12...
LWF-2	50×150	H	V	16	144	213	1,270	13.9	4.119.00.050150.85HV22.16...
LWF-2	50×150	H	V	20	142	298	1,523	16.4	4.119.00.050150.85HV22.20...
LWF-2	50×150	H	V	25	138	400	1,719	19.6	4.119.00.050150.85HV22.25...

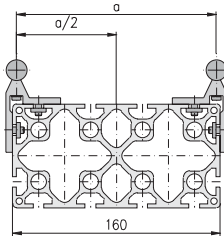

Descr.	Base profile		Shaft		Moment of i.			G	Article-No.
	Dim.	L1	L2	Ø	a	I _x	I _y		
LWF-2	80×160	H	V	12	152	446	1,536	14.9	4.119.00.080160.124HV22.12...
LWF-2	80×160	H	V	16	154	519	1,651	16.3	4.119.00.080160.124HV22.16...
LWF-2	80×160	H	V	20	152	656	1,941	18.8	4.119.00.080160.124HV22.20...
LWF-2	80×160	H	V	25	148	814	2,168	22.0	4.119.00.080160.124HV22.25...

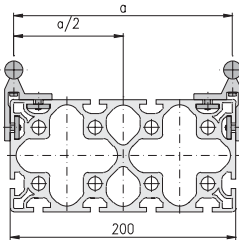

Descr.	Base profile		Shaft		Moment of i.			G	Article-No.
	Dim.	L1	L2	Ø	a	I _x	I _y		
LWF-2	100×200	H	V	12	192	1,040	3,530	21.9	4.119.00.100200.124HV22.12...
LWF-2	100×200	H	V	16	194	1,147	3,711	23.3	4.119.00.100200.124HV22.16...
LWF-2	100×200	H	V	20	192	1,359	4,176	25.8	4.119.00.100200.124HV22.20...
LWF-2	100×200	H	V	25	188	1,603	4,550	29.0	4.119.00.100200.124HV22.25...

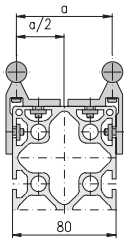

Descr.	Base profile		Shaft		Moment of i.			G	Article-No.
	Dim.	L1	L2	Ø	a	I _x	I _y		
LWF-2	80×160	V	V	12	72	1,494	414	14.9	4.119.00.080160.124VV22.12...
LWF-2	80×160	V	V	16	74	1,655	442	16.3	4.119.00.080160.124VV22.16...
LWF-2	80×160	V	V	20	72	1,966	507	18.8	4.119.00.080160.124VV22.20...
LWF-2	80×160	V	V	25	68	2,295	550	22.0	4.119.00.080160.124VV22.25...

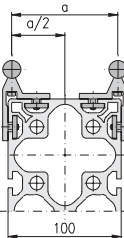

Descr.	Base profile		Shaft		Moment of i.			G	Article-No.
	Dim.	L1	L2	Ø	a	I _x	I _y		
LWF-2	100×200	V	V	12	92	3,531	988	21.9	4.119.00.100200.124VV22.12...
LWF-2	100×200	V	V	16	94	3,792	1,032	23.3	4.119.00.100200.124VV22.16...
LWF-2	100×200	V	V	20	92	4,340	1,138	25.8	4.119.00.100200.124VV22.20...
LWF-2	100×200	V	V	25	88	4,901	1,213	29.0	4.119.00.100200.124VV22.25...

for shaft-Ø12

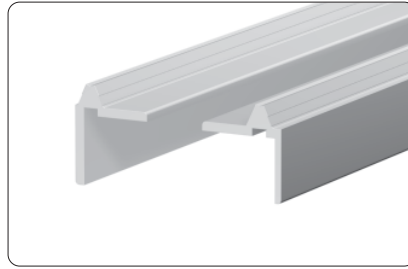

Technical data

- material: Al Mg Si 0,5 F 25
- surface: neutral anodised
- length: 6 m
- height and side tolerance:
 - to specified length: ± 0.2 mm
 - within one bar: 0.1 mm

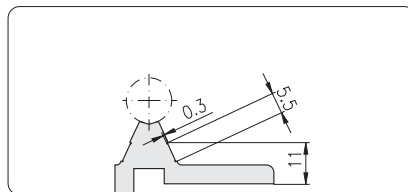
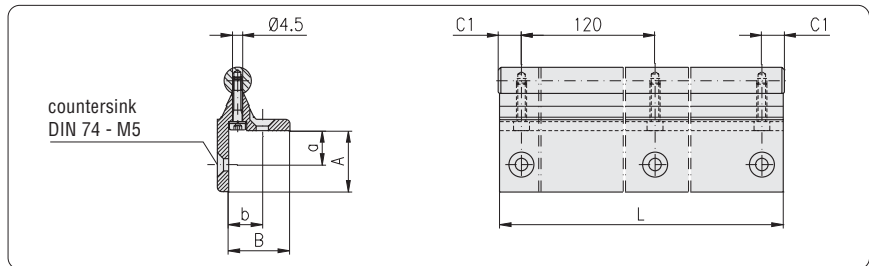

Calculation of C1:

$$C1 = 1/2 \cdot (L - n \cdot 120)$$

n = maximum number of divisions

Cut to length: 4.119.0□.12.□□□□□□□□-02/... (/... = length in mm)

Type A

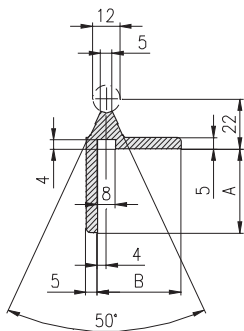

Moment of inertia	cm ⁴	I _x = 8.5	I _y = 6.6
Moment of resistance	cm ³	W _x = 2.6	W _y = 2.2
Weight (G)	kg/m		

Description	A	a	B	b	G	Article-No.
Shaft guidance profile 12A	37	-	37	-	1.30	4.119.0A.12.37003700.60
Shaft guidance profile 12A	27	15.0	27	15.0	1.03	4.119.0A.12.27152715.60
Shaft guidance profile 12A	27	15.0	37	15.0	1.17	4.119.0A.12.27153715.60
Shaft guidance profile 12A	27	15.0	37	25.0	1.17	4.119.0A.12.27153725.60
Shaft guidance profile 12A	37	20.0	37	20.0	1.30	4.119.0A.12.37203720.60
Shaft guidance profile 12A	37	22.5	37	22.5	1.30	4.119.0A.12.37223722.60
Shaft guidance profile 12A	37	25.0	27	15.0	1.17	4.119.0A.12.37252715.60
Shaft guidance profile 12A	37	25.0	37	25.0	1.30	4.119.0A.12.37253725.60

Type B

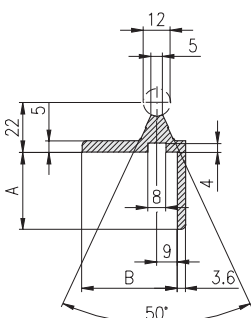

Moment of inertia	cm ⁴	I _x = 5.2	I _y = 2.8
Moment of resistance	cm ³	W _x = 1.6	W _y = 1.0
Weight (G)	kg/m		

Description	A	a	B	b	G	Article-No.
Shaft guidance profile 12B	34	-	42	-	1.20	4.119.0B.12.34004200.60
Shaft guidance profile 12B	34	15.0	32	20.0	1.07	4.119.0B.12.34153220.60
Shaft guidance profile 12B	34	15.0	42	20.0	1.20	4.119.0B.12.34154220.60
Shaft guidance profile 12B	34	15.0	42	30.0	1.20	4.119.0B.12.34154230.60
Shaft guidance profile 12B	34	20.0	42	25.0	1.20	4.119.0B.12.34204225.60
Shaft guidance profile 12B	34	22.5	42	27.5	1.20	4.119.0B.12.34224227.60
Shaft guidance profile 12B	34	25.0	32	20.0	1.07	4.119.0B.12.34253220.60
Shaft guidance profile 12B	34	25.0	42	30.0	1.20	4.119.0B.12.34254230.60

for shaft-Ø16

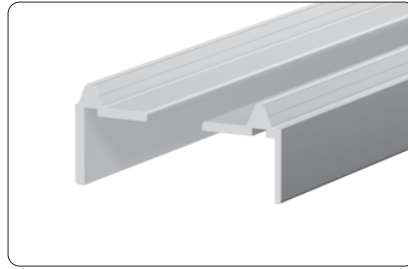

Technical data

material: Al Mg Si 0,5 F 25
 surface: neutral anodised
 length: 6 m
 height and side tolerance:
 • to specified length: ± 0.2 mm
 • within one bar: 0.1 mm

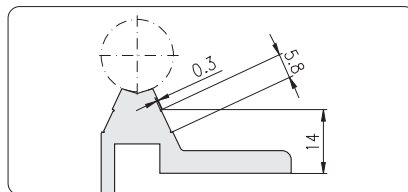
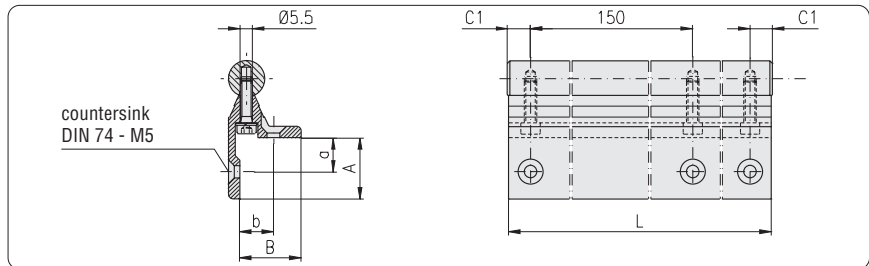

Calculation of C1:

$$C1 = 1/2 \cdot (L - n \cdot 150)$$

n = maximum number of divisions

Cut to length: 4.119.0□.16.□□□□□□□□-02/... (/... = length in mm)

Type A

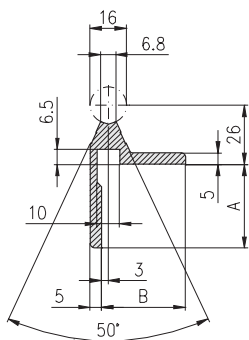

Moment of inertia	cm ⁴	I _x = 10.1	I _y = 6.6
Moment of resistance	cm ³	W _x = 3.0	W _y = 2.2
Weight (G)	kg/m		

Description	A	a	B	b	G	Article-No.
Shaft guidance profile 16A	37	-	37	-	1.30	4.119.0A.16.37003700.60
Shaft guidance profile 16A	27	15.0	27	15.0	1.03	4.119.0A.16.27152715.60
Shaft guidance profile 16A	27	15.0	37	15.0	1.17	4.119.0A.16.27153715.60
Shaft guidance profile 16A	27	15.0	37	25.0	1.17	4.119.0A.16.27153725.60
Shaft guidance profile 16A	37	15.0	27	15.0	1.17	4.119.0A.16.37152715.60
Shaft guidance profile 16A	37	20.0	37	20.0	1.30	4.119.0A.16.37203720.60
Shaft guidance profile 16A	37	22.5	37	22.5	1.30	4.119.0A.16.37223722.60
Shaft guidance profile 16A	37	25.0	27	15.0	1.17	4.119.0A.16.37252715.60
Shaft guidance profile 16A	37	25.0	37	25.0	1.30	4.119.0A.16.37253725.60

Type B

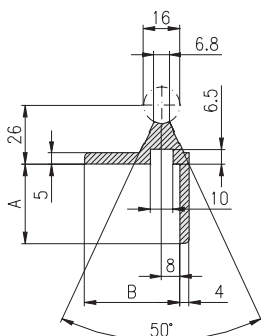

Moment of inertia	cm ⁴	I _x = 7.0	I _y = 8.0
Moment of resistance	cm ³	W _x = 2.1	W _y = 2.6
Weight (G)	kg/m		

Description	A	a	B	b	G	Article-No.
Shaft guidance profile 16B	35	-	42	-	1.30	4.119.0B.16.35004200.60
Shaft guidance profile 16B	35	15.0	32	20.0	1.17	4.119.0B.16.35153220.60
Shaft guidance profile 16B	35	15.0	42	20.0	1.30	4.119.0B.16.35154220.60
Shaft guidance profile 16B	35	15.0	42	30.0	1.30	4.119.0B.16.35154230.60
Shaft guidance profile 16B	35	20.0	42	25.0	1.30	4.119.0B.16.35204225.60
Shaft guidance profile 16B	35	22.5	42	27.5	1.30	4.119.0B.16.35224227.60
Shaft guidance profile 16B	35	25.0	32	20.0	1.17	4.119.0B.16.35253220.60
Shaft guidance profile 16B	35	25.0	42	30.0	1.30	4.119.0B.16.35254230.60

for shaft-Ø20

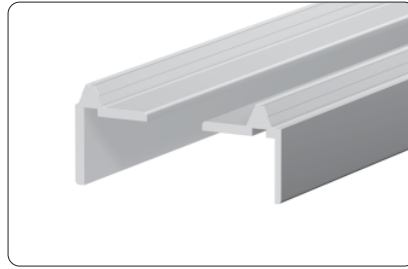

Technical data

- material: Al Mg Si 0,5 F 25
- surface: neutral anodised
- length: 6 m
- height and side tolerance:
 - to specified length: ± 0.2 mm
 - within one bar: 0.1 mm

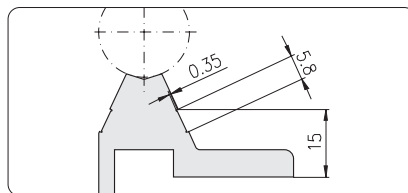
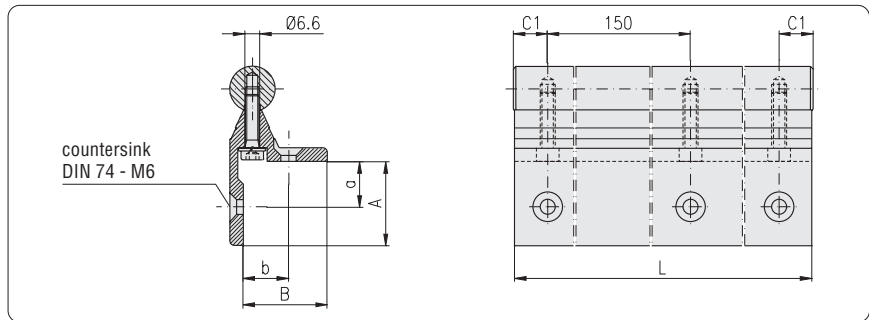

Calculation of C1:

$$C1 = 1/2 \cdot (L - n \cdot 120)$$

n = maximum number of divisions

Cut to length: 4.119.0□.20.□□□□□□□□-02/... (/... = length in mm)

Type A

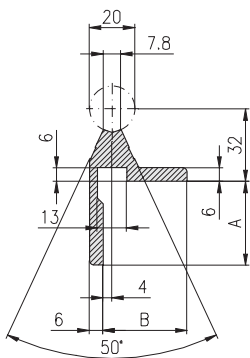

Moment of inertia	cm ⁴	I _x = 14.6	I _y = 8.4
Moment of resistance	cm ³	W _x = 4.0	W _y = 2.8
Weight (G)	kg/m		

Description	A	a	B	b	G	Article-No.
Shaft guidance profile 20A	37	-	37	-	1.7	4.119.0A.20.37003700.60
Shaft guidance profile 20A	37	20.0	37	20.0	1.7	4.119.0A.20.37203720.60
Shaft guidance profile 20A	37	22.5	37	22.5	1.7	4.119.0A.20.37223722.60
Shaft guidance profile 20A	37	25.0	37	25.0	1.7	4.119.0A.20.37253725.60

Type B

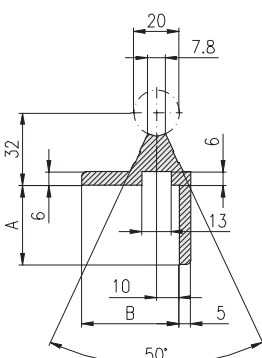

Moment of inertia	cm ⁴	I _x = 10.5	I _y = 11.2
Moment of resistance	cm ³	W _x = 2.9	W _y = 3.5
Weight (G)	kg/m		

Description	A	a	B	b	G	Article-No.
Shaft guidance profile 20B	35	-	43	-	1.7	4.119.0B.20.35004300.60
Shaft guidance profile 20B	35	20.0	43	26.0	1.7	4.119.0B.20.35204326.60
Shaft guidance profile 20B	35	22.5	43	28.5	1.7	4.119.0B.20.35224328.60
Shaft guidance profile 20B	35	25.0	43	31.0	1.7	4.119.0B.20.35254331.60

for shaft-Ø25

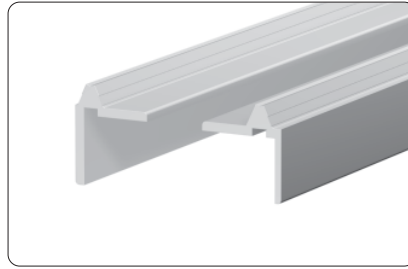

Technical data

- material: Al Mg Si 0,5 F 25
- surface: neutral anodised
- length: 6 m
- height and side tolerance:
 - to specified length: ± 0.2 mm
 - within one bar: 0.1 mm

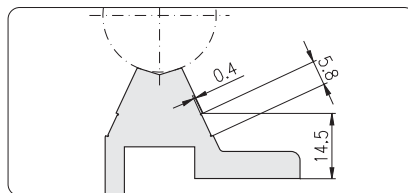
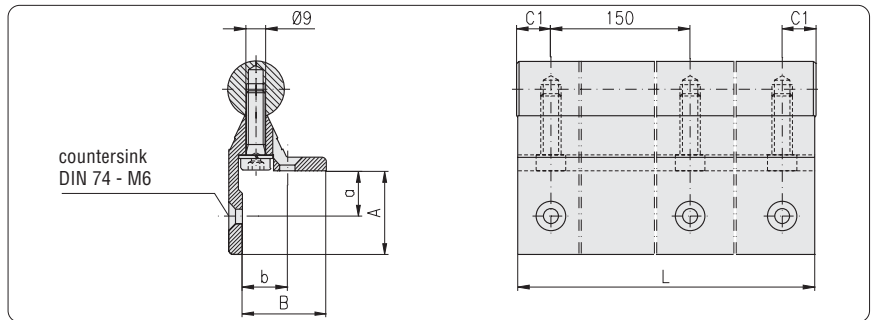

Calculation of C1:

$$C1 = 1/2 \cdot (L - n \cdot 120)$$

n = maximum number of divisions

Cut to length: 4.119.0□.25.□□□□□□□□-02/... (/... = length in mm)

Type A

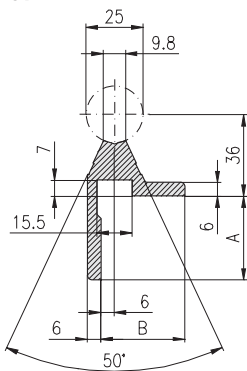

Moment of inertia	cm ⁴	I _x = 16.6	I _y = 8.7
Moment of resistance	cm ³	W _x = 4.4	W _y = 2.9
Weight (G)	kg/m		

Description	A	a	B	b	G	Article-No.
Shaft guidance profile 25A	37	-	37	-	1.9	4.119.0A.25.37003700.60
Shaft guidance profile 25A	37	20.0	37	20.0	1.9	4.119.0A.25.37203720.60
Shaft guidance profile 25A	37	22.5	37	22.5	1.9	4.119.0A.25.37223722.60
Shaft guidance profile 25A	37	25.0	37	25.0	1.9	4.119.0A.25.37253725.60

Type B

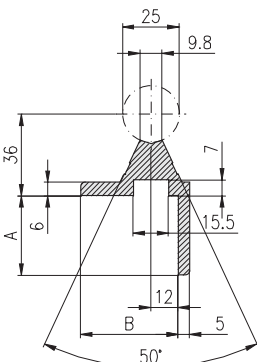

Moment of inertia	cm ⁴	I _x = 11.7	I _y = 10.6
Moment of resistance	cm ³	W _x = 3.1	W _y = 3.4
Weight (G)	kg/m		

Description	A	a	B	b	G	Article-No.
Shaft guidance profile 25B	35	-	43	-	1.9	4.119.0B.25.35004300.60
Shaft guidance profile 25B	35	20.0	43	26.0	1.9	4.119.0B.25.35204326.60
Shaft guidance profile 25B	35	22.5	43	28.5	1.9	4.119.0B.25.35224328.60
Shaft guidance profile 25B	35	25.0	43	31.0	1.9	4.119.0B.25.35254331.60

Shafts

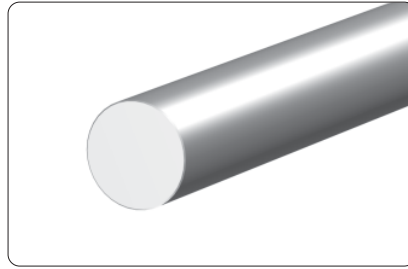

Coated steel

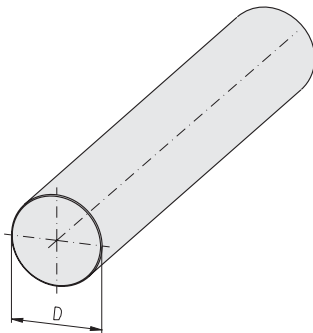

Technical data

material: coated steel
 surface: edge layer hardened, polished
 coat hardness: 670 + 170HV (59 + 6HRC)
 length of bar: 6 m, ends unchamfered
 weight (G): kg/m

Description	D	Roundness	Parallelism	G	Article-No.
Shaft	12 h6	5 µm	8 µm	0.89	4.119.0W.11.12.60
Shaft	16 h6	5 µm	8 µm	1.57	4.119.0W.11.16.60
Shaft	20 h6	6 µm	9 µm	2.45	4.119.0W.11.20.60
Shaft	25 h6	6 µm	9 µm	3.83	4.119.0W.11.25.60

Noncorroding steel X46Cr13

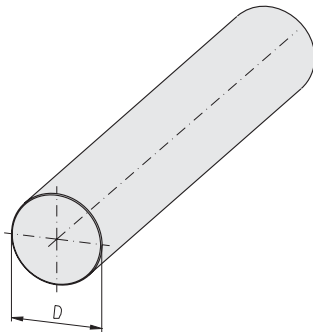

Technical data

material: X46Cr13
 surface: polished
 coat hardness: 560 + 60HV (54 + 3HRC)
 length of bar: 6 m, ends unchamfered
 weight (G): kg/m

Description	D	Roundness	Parallelism	G	Article-No.
Shaft X46Cr13	12 h6	5 µm	8 µm	0.89	4.119.0W.12.12.60
Shaft X46Cr13	16 h6	5 µm	8 µm	1.57	4.119.0W.12.16.60
Shaft X46Cr13	20 h6	6 µm	9 µm	2.45	4.119.0W.12.20.60
Shaft X46Cr13	25 h6	6 µm	9 µm	3.83	4.119.0W.12.25.60

Shafts

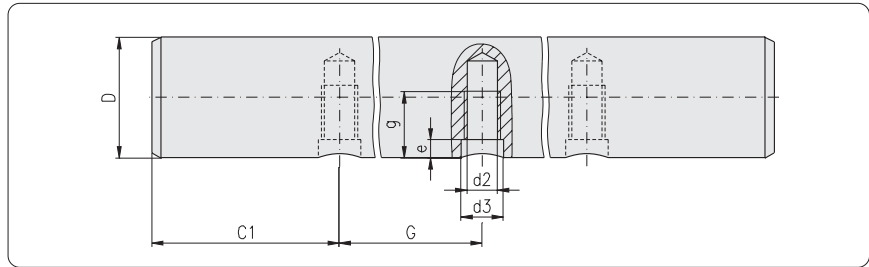
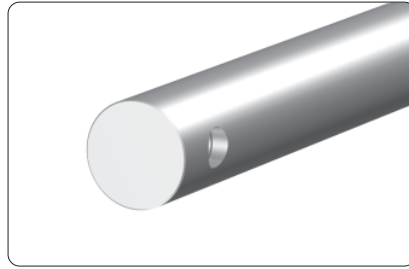

D	d1	d2	d3	g	e	C _{1 min} ¹⁾	G	
12 mm	M5	M4	5	8	2.0	10	120	¹⁾ For applications with axial thread C1 has to be adapted for the drilling depth of the axial thread EN 42
16 mm	M6	M5	6	9	2.5	10	150	
20 mm	M8	M6	7	11	3.0	10	150	
25 mm	M10	M8	9	15	3.0	15	150	

Calculation of C1:

$$C1 = 1/2 \cdot (L - n \cdot G)$$

n = maximum number of divisions

Coated steel

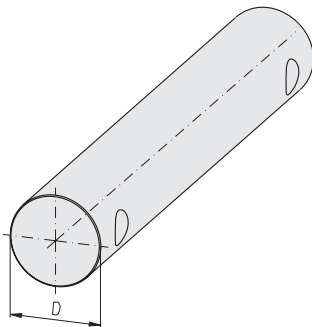

Technical data

material: coated steel
 surface: edge layer hardened, polished
 coat hardness: 670 + 170HV (59 + 6HRC)
 length of bar: 6 m, ends unchamfered
 weight (G): kg/m

Description	D	Roundness	Parallelism	G	Article-No.
Shaft	12 h6	5 μm	8 μm	0.89	4.119.0W.21.12.60
Shaft	16 h6	5 μm	8 μm	1.57	4.119.0W.21.16.60
Shaft	20 h6	6 μm	9 μm	2.45	4.119.0W.21.20.60
Shaft	25 h6	6 μm	9 μm	3.83	4.119.0W.21.25.60

Noncorroding steel X46Cr13

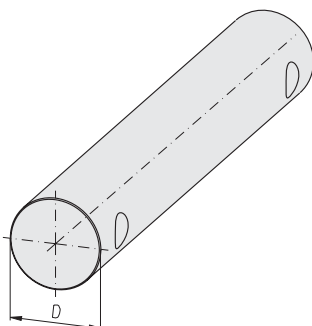

Technical data

material: X46Cr13
 surface: polished
 coat hardness: 560 + 60HV (54 + 3HRC)
 length of bar: 6 m, ends unchamfered
 weight (G): kg/m

Description	D	Roundness	Parallelism	G	Article-No.
Shaft X46Cr13	12 h6	5 μm	8 μm	0.89	4.119.0W.22.12.60
Shaft X46Cr13	16 h6	5 μm	8 μm	1.57	4.119.0W.22.16.60
Shaft X46Cr13	20 h6	6 μm	9 μm	2.45	4.119.0W.22.20.60
Shaft X46Cr13	25 h6	6 μm	9 μm	3.83	4.119.0W.22.25.60

Machining of shafts

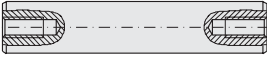
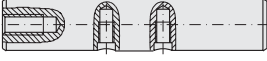
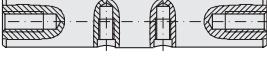
Description	
	Machining of shaft - 1 axial thread
	Machining of shaft - 2 axial threads
	Machining of shaft - 1 axial and radial thread
	Machining of shaft - 2 axial and radial threads

Dimensions for machining of shafts

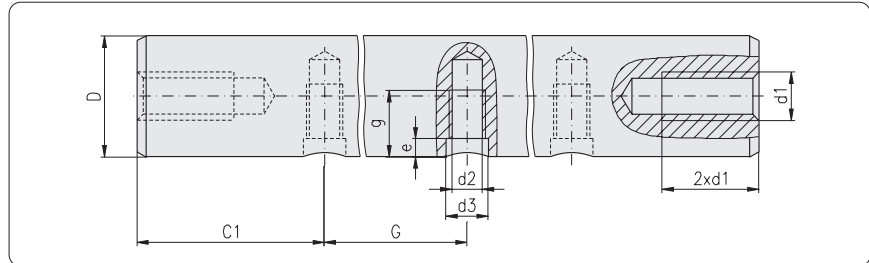

D	d1	d2	d3	g	e	C _{1 min} ¹⁾	G	
12 mm	M5	M4	5	8	2.0	10	120	1) For applications with axial thread C1 has to be adapted for the drilling depth of the axial thread
16 mm	M6	M5	6	9	2.5	10	150	
20 mm	M8	M6	7	11	3.0	10	150	
25 mm	M10	M8	9	15	3.0	15	150	

Calculation of C1:

$C1 = 1/2 \cdot (L - n \cdot G)$

n = maximum number of divisions

Straightness tolerance for shafts cut to length

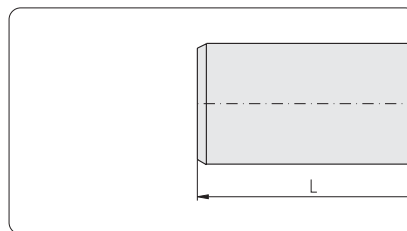

Length	Tolerance
0 - 400	± 0.5
400 - 1,000	± 0.8
1,000 - 2,000	± 1.2
2,000 - 4,000	± 2.0
4,000 - 6,000	± 3.0

Chamfer on a shaft side

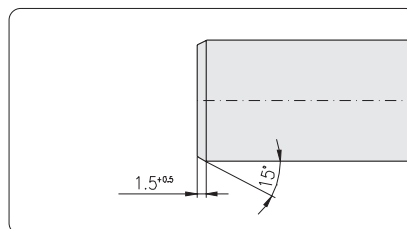

Order example

bar 6 m	4.119.0W.11.12.60	
cut to length	4.119.0W.11.12-□□□□□/□□□□	
	4.119.0W.11.12- S □□□□□/□□□□	cut
	4.119.0W.11.12- F □□□□□/□□□□	left chamfer
	4.119.0W.11.12-□□ A □□□□□/□□□□	left axial thread
	4.119.0W.11.12-□□□ F □□□□□/□□□□	right chamfer
	4.119.0W.11.12-□□□□□ A □□□□□/□□□□	right axial thread
	4.119.0W.11.12-□□□□□□□□□□/□□□□□□	length in mm

Linear unit

- toothed belt drive
- shaft guidance
- turning unit with primary shaft on one side



Measuring system

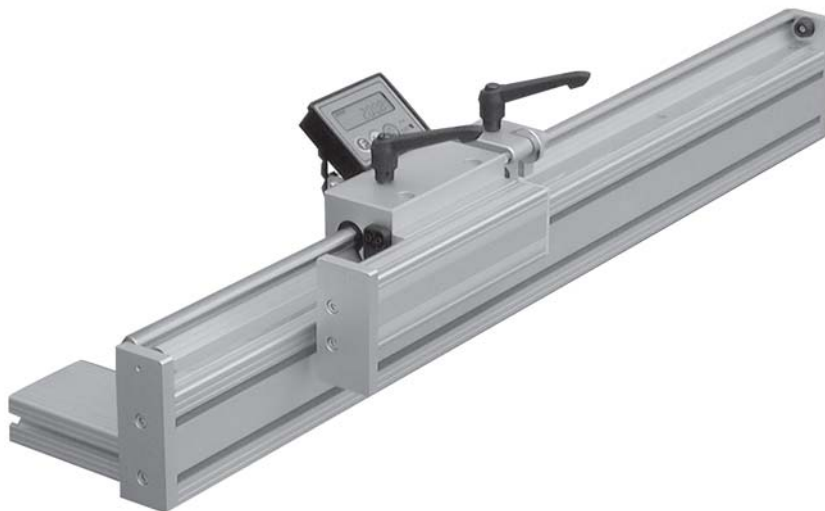

Imprint

Subject to technical modification.

All rights reserved.

Copying - also in parts - only allowed by
written consent.

© MayTec Aluminium Systemtechnik GmbH,
Germany, D - 85221 Dachau, 2006

The key...

to success

- 30% - 600% more flexible design
- 20% - 50% more economical machining
- 60% - 340% quicker assembly
- 100% - 260% stronger connection
- more than 60 service locations

Australia

MayTec Australia P/L
Unit 1, 8 Prosperity Parade
Warriewood, NSW 2102

country code: +61
phone (0) 2 / 9999 0890
fax (0) 2 / 9979 8703
e-mail: info@maytec.com.au
<http://www.maytec.com.au>

Germany

MayTec Aluminium
Systemtechnik GmbH
Kopernikusstraße 20
D - 85221 Dachau

country code: +49
phone (0) 8131 / 33 36 - 0
fax (0) 8131 / 33 36 - 119
e-mail: mail@maytec.de
<http://www.maytec.de>

USA

MayTec Inc.
1625 Dundee Ave., Unit E-F
Elgin, IL 60120

country code: +1
phone 847 - 429 - 0321
fax 847 - 429 - 0460
e-mail: mail@maytecinc.com
<http://www.maytecinc.com>

Your professional partner