

# Pro-Line II Drawer System

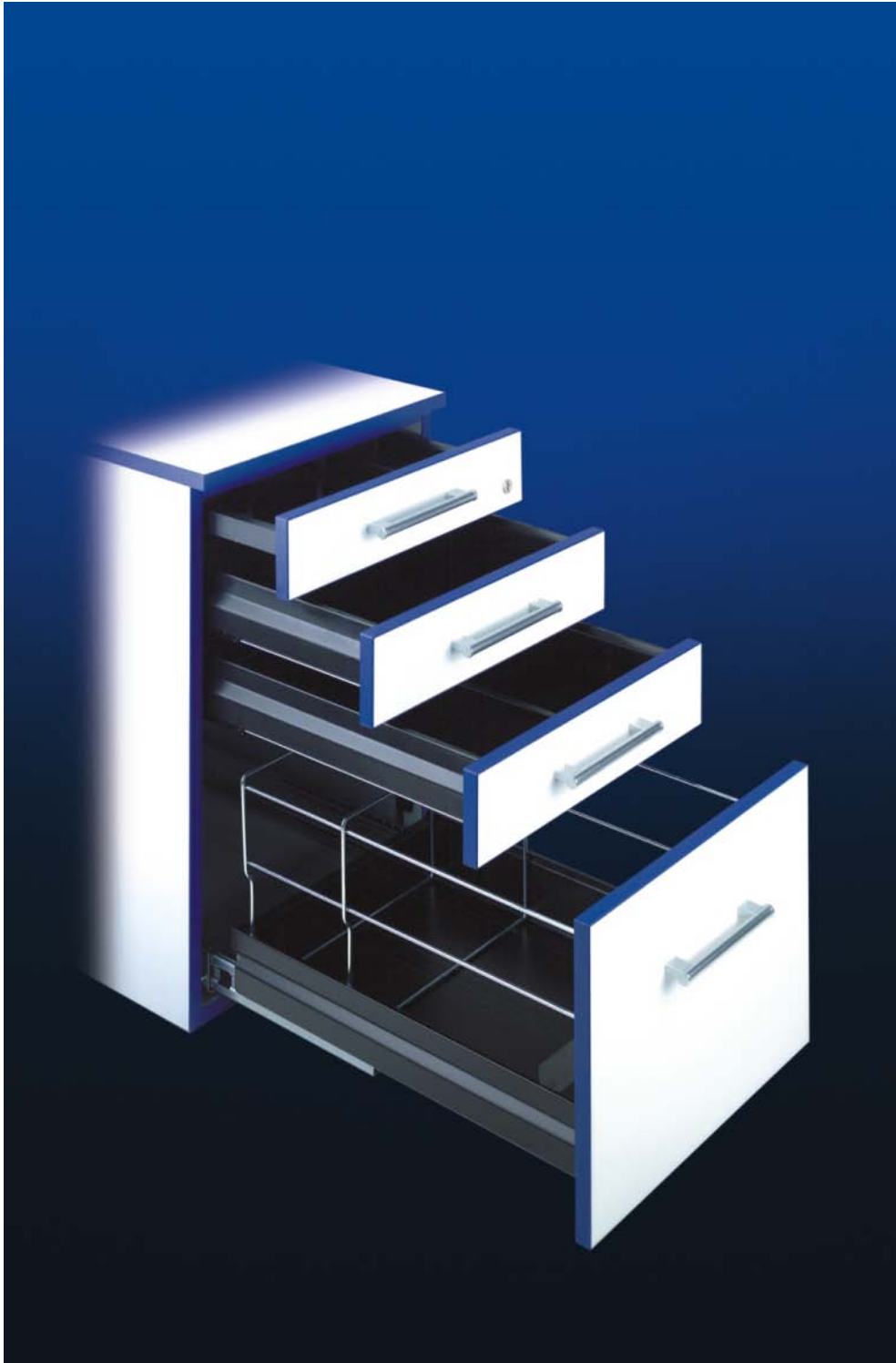

**SCHOCK**  
M E T A L L

# Professional office furnishing.

With regard to both function and design, the Pro-Line II drawer system has been carefully thought out. Clean lines and handsome, matt-finished surfaces give the furniture a practical yet chic look. The high-quality, long-life precision ball bearing slides from Schock are fully concealed under elegantly formed shrouds. The drawers can be fully extended to provide the highest level of utility and comfort. The flexible design permits customer-specific solutions to be easily created.

Pro-Line II is ideally suited for installation in office desks, rolling cabinets, and mobile "caddies". The system was developed with the needs of modern office organization in mind, offering useful advantages to both manufacturers of office furniture as well as end users.

## ● **Schock precision ball bearing slides**

- Full extension for 30 - 50 kg loads
- Identical mounting positions
- Smooth running, long life durability

## ● **Schock steel drawers**

- Variable widths and depths available
- Space-saving stocking and transport
- Assembly without tools

## ● **Locking system connection**

- Plug-in lock-catch plates
- Suitable for standard locking device as well as the modern systems e. g. Huwil, Lehmann, and Ojmar.



Pro-Line II  
steel drawer  
with dividers  
and pencil tray

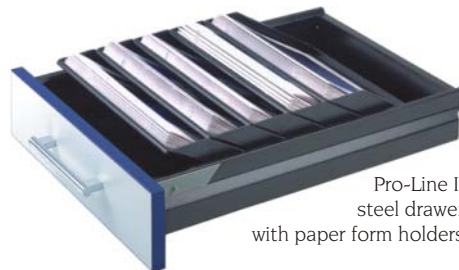

Pro-Line II  
steel drawer  
with paper form holders

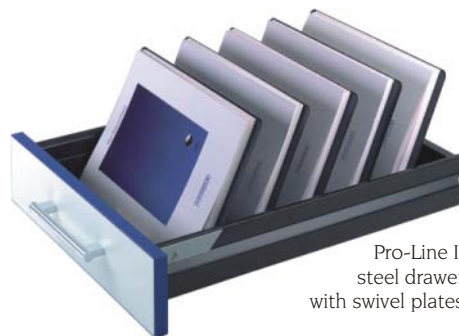

Pro-Line II  
steel drawer  
with swivel plates

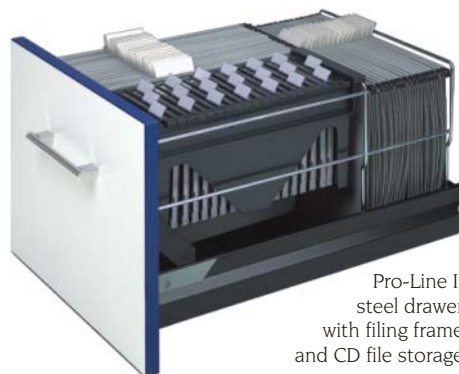

Pro-Line II  
steel drawer  
with filing frame  
and CD file storage

# Flexible installation system.

Pro-Line II is designed in 25 and 32 mm systems for industrial office furniture manufacturing as well as home office furniture. Drawers and ball bearing slides are available in all current interior cabinet dimensions. Special sizes to fit individual customer needs can also be manufactured. All slides have identical mounting positions and can be easily combined in any way.

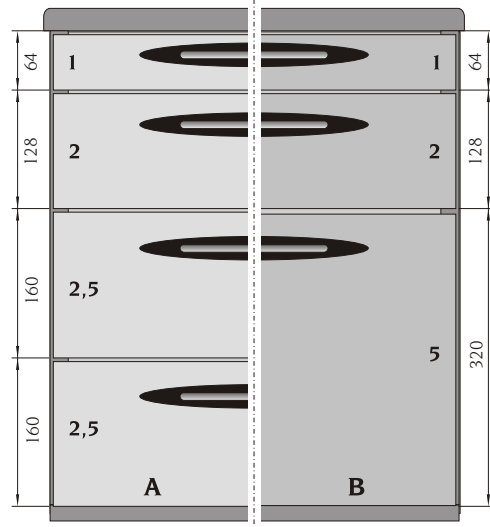
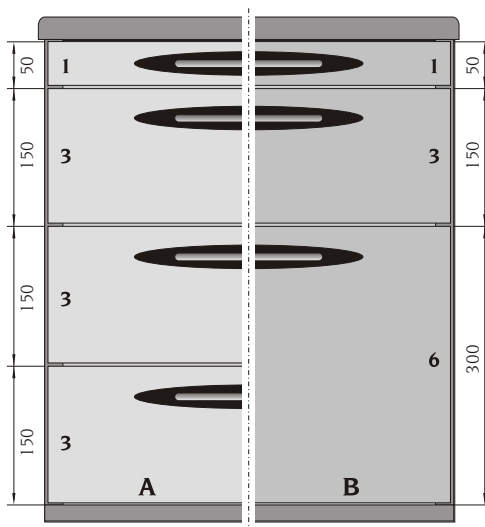
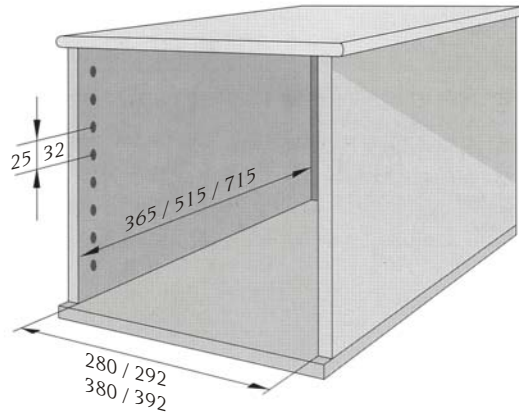

**A)** Cabinet with  
1 pedestal tray  
3 drawers

**B)** Cabinet with  
1 pedestal tray  
1 drawer  
1 drawer with  
filing frame

## Schock precision ball bearing slides:

An important benefit of the Pro-Line II drawer system is given in its flexibility concerning functional features and comfort. According to the particular market requirements, partial and full extension slides with different features and load rates can be used:

- Part extension Serie 017 (10 kgs)
- Part extension Serie 010 (20 kgs)
- Full extension Serie 016 (30 kgs)
- Full extension Serie 072 (40 kgs)\*
- Full extension Serie 036 (50 kgs)

\* on request (alternatively to Serie 016 / 036)



# Pedestal tray with ball bearing slide.

The Pro-Line pedestal tray is made of recyclable polystyrene. The fully concealed Schock precision ball bearing slide ensures easy and smooth running. The front panel is installed using integrated dowels. The standard colour is black.

The pedestal tray is designed for right-handed locking systems: distance [front edge of cabinet to centre of locking rod] = 37 mm

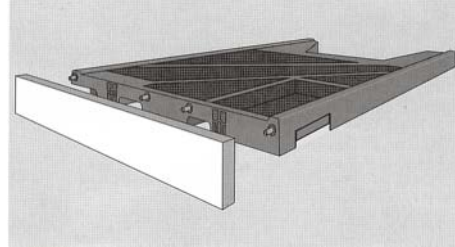

Front fixed with dowels

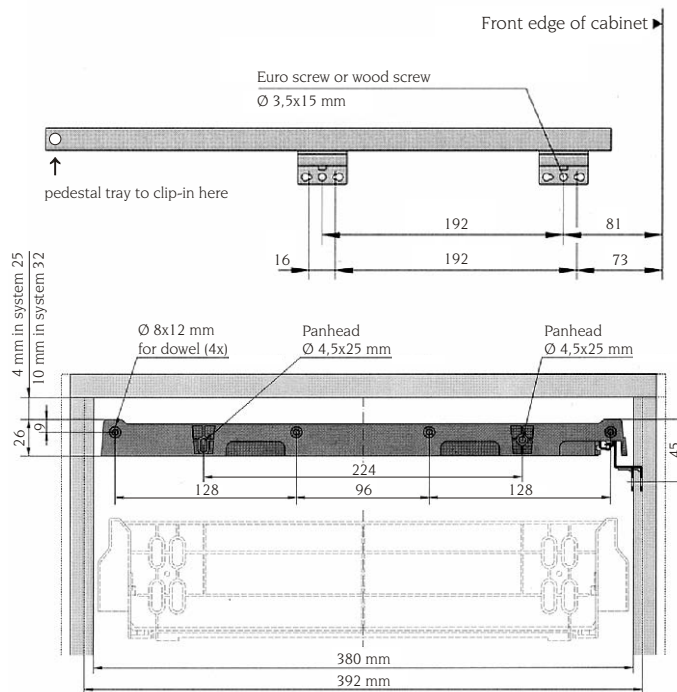

## Part extension Serie 017 (10 kgs)



### Material:

hot galvanized steel

### Mounting:

screw the slides with the welded brackets into the cabinet (dowel version available on request); insert the pedestal tray and clip into the slides.

# Pro-Line II steel drawer.

The Pro-Line II steel drawer was developed in response to current market requirements. It is available in a variety of widths and depths. The split front allows the drawers to be stacked inside each other, saving space and offering economic shipping.

The standard colour is black. Special colours as well as special logistic concepts (i. e. delivery of uncoated or unmounted blank drawers) can be realised on request.

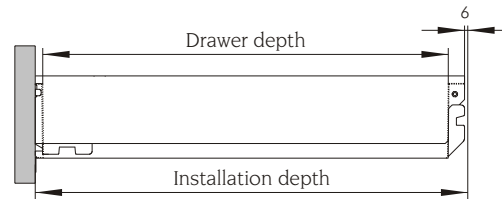
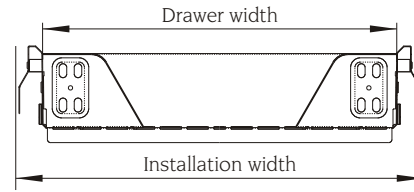

## Pro-Line II drawer dimensions

<b>Cabinet width (mm)</b> <sup>1</sup>			318 / 330	418 / 430	463 / 475
<b>Installation width (mm)</b> <sup>2</sup>			280 / 292	380 / 392	425 / 437
<b>Drawer width (mm)</b>			230	330	375
<b>Cabinet depth</b>	<b>Installation depth</b>	<b>Drawer depth</b>			
400	365	335	-	•	-
600	515	485	•	•	-
800	715	685	x	•	x

1 with 19 mm side wall thickness

2 with locking rod running in a groove / mounted onto the wall

• standard  
x on request

# Schock precision ball bearing slides.

## Part extension Serie 010 (20 kgs)



<b>Extension</b>	75%
<b>Material</b>	hot galvanized steel; cabinet brackets made of metal
<b>Features</b>	roll-out prevention (self closing device on request)

<b>Cabinet mounting</b>	screw the slides with the welded brackets into the cabinet (dowel version available on request)
<b>Drawer mounting</b>	snap-connection

## Full extension Serie 016 (30 kgs)



<b>Extension</b>	100% with gliding section
<b>Material</b>	hot galvanized steel; outer profile black epoxy-coated; gliding blocks made of plastic
<b>Features</b>	roll-out prevention

<b>Cabinet mounting</b>	screw the gliding blocks into the cabinet (dowel version available on request); clip the slides into the gliding blocks
<b>Drawer mounting</b>	bayonet lancements (snap-connection on request)

## Full extension Serie 036 (50 kgs)



<b>Extension</b>	100% +30 mm over-extension
<b>Material</b>	hot galvanized steel; cabinet brackets made of metal
<b>Features</b>	roll-out prevention (self closing device on request)

<b>Cabinet mounting</b>	screw the brackets into the cabinet (dowel version available on request); hang the slides into the brackets
<b>Drawer mounting</b>	bayonet lancements (snap-connection on request)

# Final assembly without tools.

## Mounting the lock-catch plate

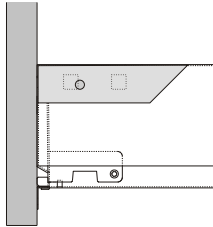

Insert the lock-catch plate (see page 10 for the complete selection) into the square holes on the front of the right shroud.

The lock-catch plate will be fixed in place by the front panel.

## Mounting the front panel supports (for drawers with filing frame)

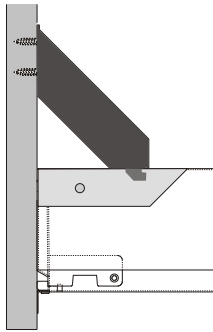

Insert the front panel supports in the upper slots on the drawer.

Fasten the front panel with  $\varnothing 4 \times 17$  mm wood screws.

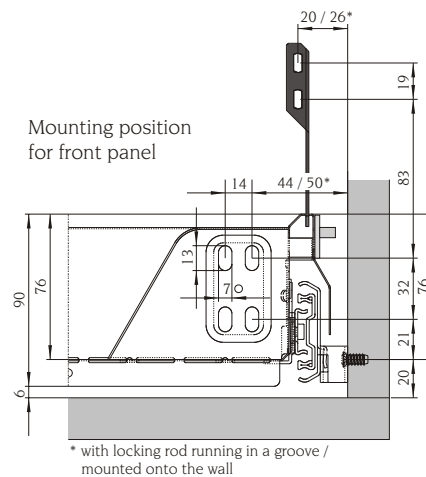

## Final assembly with snap-connection

- 1) Pull out the slide rails.
- 2) Put the drawer onto the slides and push in.

## Final assembly with bayonets

- 1) Pull out the slide rails completely.
- 2) Put the drawer onto the rear slide brackets and push in. Keep the slides in extended position during this step.
- 3) Plug the drawer on its front cutouts in the bayonets of the slides.
- 4) Push in the drawer.





# Vertical graduation system 32 mm.

The production of cabinets comprises three standard depths. The fronts are divided in standard height units (HE). Example:

- 1 HE Pedestal tray**
- 2 HE Drawer**
- 2,5 HE Drawer**
- 6 HE Drawer with filing frame**

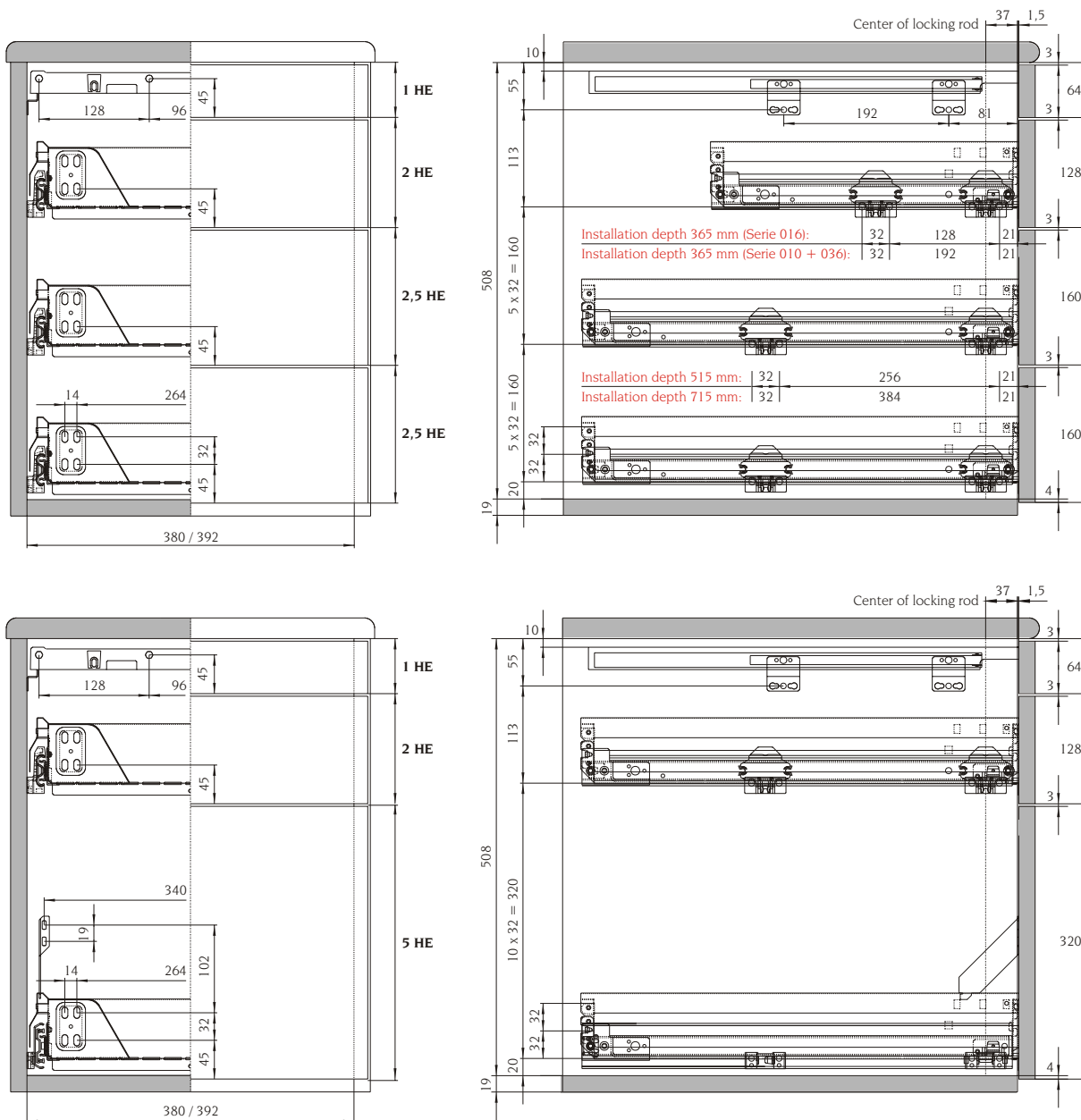
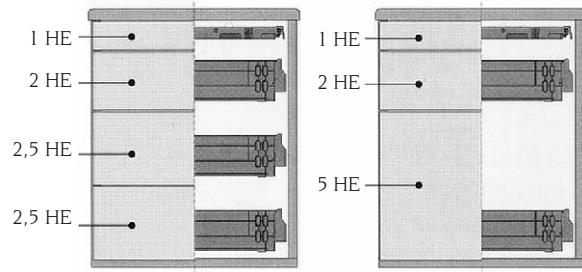

Drilling holes  $\varnothing$  5 for Euro screws (standard)  
 $\varnothing$  8 for plastic dowels (on request)

**Please ask for 1:1 installation drawings for your particular container variants!**

# Connection to locking systems.

Pro-Line II is designed to accommodate the modern locking systems offered by Huwil, Lehmann, and Ojmar. Alternately the standard locking device can also be used. The connection to the required locking system is by means of corresponding lock-catch plates:

## Lock-catch plate Huwil for system "Huwil SVS 3"



## Lock-catch plate Lehmann for system "Lehmann Simultan Stop"



## Lock-catch plate Ojmar for system "Ojmar Sistema 1038"



## Lock-catch plate Standard for standard locking device

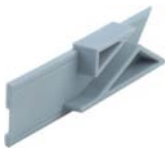

Your logo on the lock-catch plate:  
Please request!

## Anti-tilt locking system Huwil SVS 3

The height divisions reflect the examples on page 8 - 9. The system can be used for both locking rods running in a groove as well as mounted onto the wall.

### System 25 mm:

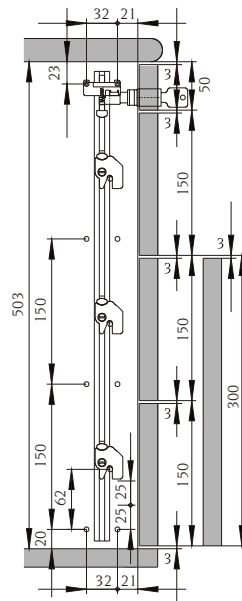

### System 32 mm:

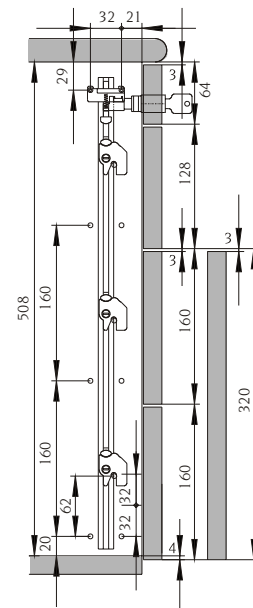

### Lock position 47 mm front:

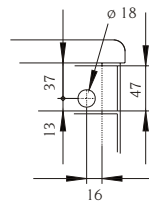

### Lock position 61 mm front:

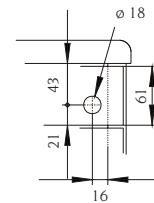

Special dimensions available on request,  
e.g., for HE 1-2-2 front panel heights.

# Connection to locking systems.

## Anti-tilt locking system Lehmann Simultan Stop

The height divisions reflect the examples on page 8 - 9. The system can only be used for wall-mounted locking rods.

## Anti-tilt locking system Ojmar Sistema 1038

The height divisions reflect the examples on page 8 - 9. The system can be used for both locking rods running in a groove as well as mounted onto the wall.

**System 25 mm:**

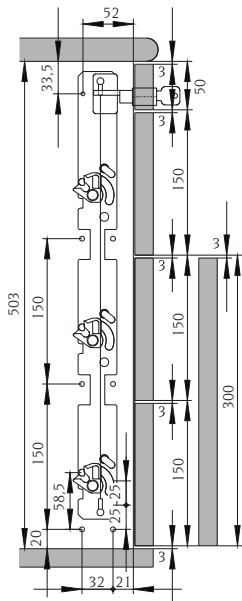

**System 32 mm:**

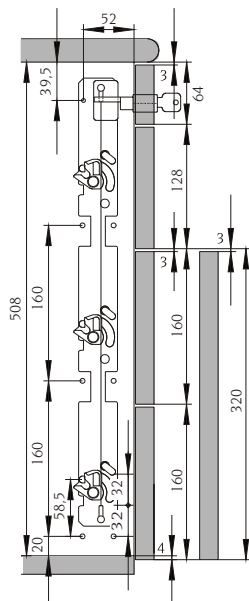

**System 25 mm:**

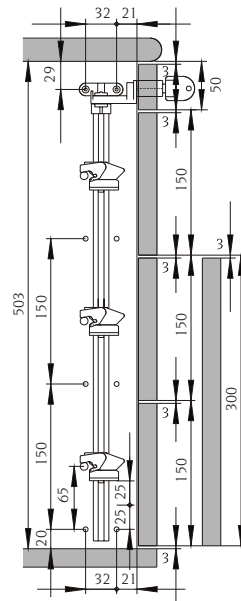

**System 32 mm:**

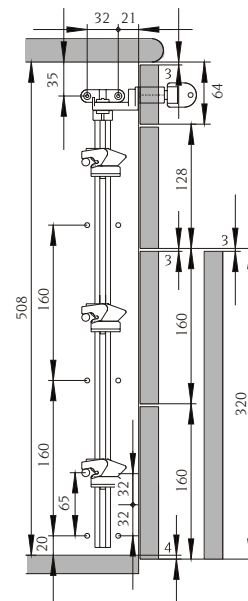

**Lock position  
47 mm front:**

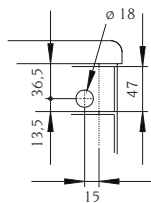

**Lock position  
61 mm front:**

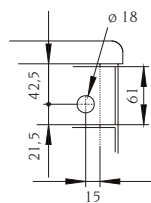

**Lock position  
47 mm front:**

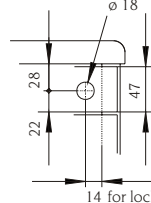

**Lock position  
61 mm front:**

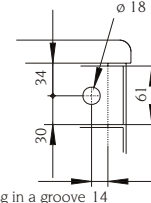

14 for locking rod running in a groove  
17 for wall-mounted locking rod

Special dimensions available on request, e.g., for HE 1-2-2 front panel heights.

Special dimensions available on request, e.g., for HE 1-2-2 front panel heights.



# Index-card formation.

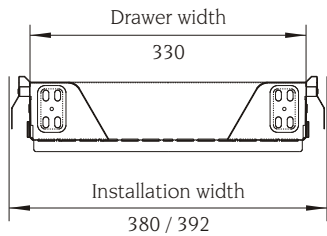

Swivel plates made of steel  
Colour: black



## Formation with divider panels for drawer depth 485 mm

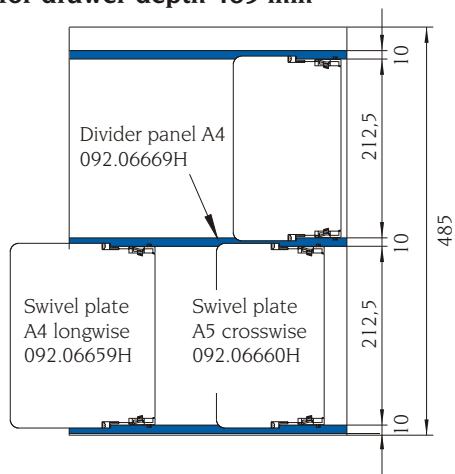

## Formation with a file rack

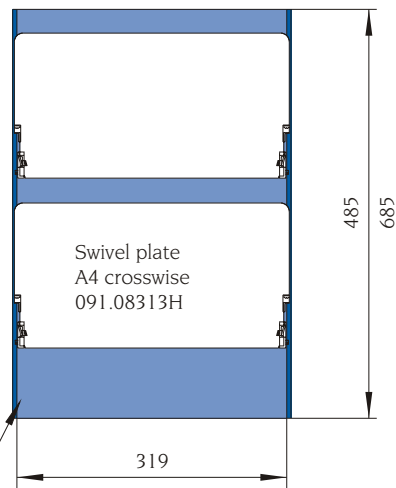

## Formation with divider panels for drawer depth 685 mm

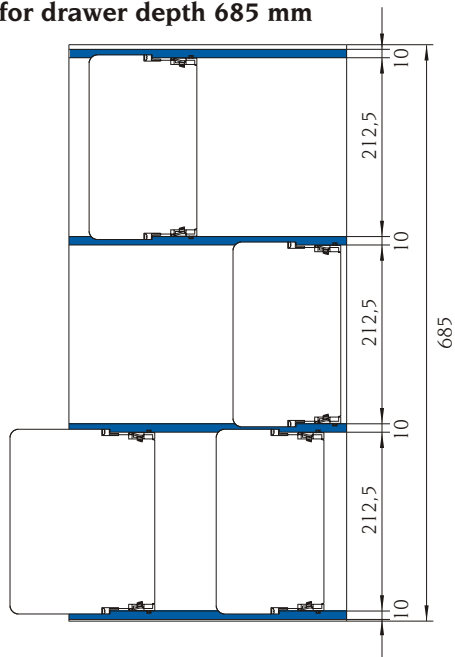

File rack for drawer depth 485 mm: 091.08314H  
File rack for drawer depth 685 mm: 091.08315H

# Order data - basic equipment.

The Pro-Line II drawer system is based on a modular design. One each item from position 1 - 3 result in a complete basic drawer.

**1 Pro-Line II steel drawer**  
**2 lock-catch plate + front panel support**  
**3 Schöck ball bearing slide**

Pos.	Page	Designation	Installation width	Drawer width	Installation depth	Drawer depth	Article No.	UQ	
<b>1</b>	5	<b>Pro-Line II steel drawer</b>							
		colour: black	280 / 292	230	515	485	<b>052.08545H</b>	10 pcs.	
			280 / 292	230	715	685	<b>on request</b>	10 pcs.	
			380 / 392	330	365	335	<b>052.08326H</b>	10 pcs.	
			380 / 392	330	515	485	<b>052.08327H</b>	10 pcs.	
			380 / 392	330	715	685	<b>052.08328H</b>	10 pcs.	
		425 / 437	375	715	685	<b>on request</b>	10 pcs.		
<b>2</b>	7/10	<b>Lock-catch plate</b>							
		colour: silver grey							
		- for standard locking device	all				<b>091.08330Z</b>	20 pcs.	
		- for Huwil SVS3	all				<b>091.08331Z</b>	20 pcs.	
		- for Lehmann Simultan Stop	292 / 392 / 437	for wall-mounted locking rod only			<b>091.08332Z</b>	20 pcs.	
	- for Ojmar Sistema 1038	280 / 380 / 425	for locking rod running in grooves			<b>091.08333Z</b>	20 pcs.		
		292 / 392 / 437	for wall-mounted locking rod		<b>091.08334Z</b>	20 pcs.			
	7	<b>Front panel support</b>							
		optional, for high front panel					<b>091.08312H</b>	20 pairs	
<b>3</b>	3/6	<b>Part extension Serie 010 (20 kgs)</b>	280 / 380 / 425	all	365	335	<b>010.08354</b>	20 pairs	
		with welded-on brackets	280 / 380 / 425	all	515	485	<b>010.08355</b>	20 pairs	
		to screw into the cabinet	280 / 380 / 425	all	715	685	<b>010.08356</b>	20 pairs	
			292 / 392 / 437	all	365	335	<b>010.08357</b>	20 pairs	
			292 / 392 / 437	all	515	485	<b>010.08358</b>	20 pairs	
			292 / 392 / 437	all	715	685	<b>010.08359</b>	20 pairs	
	3/6	<b>Full extension Serie 016 (30 kgs)</b>	280 / 380 / 425	all	365	335	<b>016.08393H</b>	20 pairs	
		including 4 plastic gliding blocks	280 / 380 / 425	all	515	485	<b>016.08394H</b>	20 pairs	
		to screw into the cabinet	280 / 380 / 425	all	715	685	<b>016.08395H</b>	20 pairs	
			292 / 392 / 437	all	365	335	<b>016.08396H</b>	20 pairs	
			292 / 392 / 437	all	515	485	<b>016.08397H</b>	20 pairs	
			292 / 392 / 437	all	715	685	<b>016.08398H</b>	20 pairs	
	3/6	<b>Full extension Serie 036 (50 kgs)</b>	280 / 380 / 425	all	365	335	<b>036.08363</b>	20 pairs	
		including 4 metal brackets	280 / 380 / 425	all	515	485	<b>036.08364</b>	20 pairs	
		to screw into the cabinet	280 / 380 / 425	all	715	685	<b>036.08365</b>	20 pairs	
			292 / 392 / 437	all	365	335	<b>036.08366</b>	20 pairs	
			292 / 392 / 437	all	515	485	<b>036.08367</b>	20 pairs	
			292 / 392 / 437	all	715	685	<b>036.08368</b>	20 pairs	
		6	<b>Retainer for locking bar</b>						
			optional, for Serie 010 + 036	all				<b>091.06141H</b>	100 pcs.

# Order data - accessories.

## Pedestal tray with ball bearing slide

The pedestal tray is designed for the standard locking device as well as for the modern locking systems Huwil SVS3 and Ojmar Sistema 1038.

For the system Lehmann Simultan Stop, a model with correspondingly adapted lock connection is available.

Page	Designation	Installation width	Drawer width	Installation depth	Drawer depth	Article No.	UQ
4	<b>Pedestal tray made of plastic</b> colour: black						
	- standard version	380 / 392	330	500	345	<b>091.06130H</b>	10 pcs.
	- for Lehmann Simultan Stop	392	330	500	345	<b>091.06870H</b>	10 pcs.
4	<b>Part extension Serie 017</b> with welded-on brackets	380	330	500	345	<b>017.05672</b>	20 pairs
	to screw into the cabinet	392	330	500	345	<b>017.05673</b>	20 pairs

## Accessories for drawer partition

Page	Designation	Installation width	Drawer width	Installation depth	Drawer depth	Article No.	UQ
12	<b>Divider panel A4</b>	380 / 392	330			<b>092.06669H</b>	20 pcs.
	<b>Divider plate DIN A5</b>	380 / 392	330			<b>092.08529H</b>	20 pcs.
	<b>Divider plate DIN A6</b>	380 / 392	330			<b>092.08528H</b>	20 pcs.
	<b>Inner front cover</b>	380 / 392	330			<b>091.08323H</b>	10 pcs.

## Accessories for index-card formation

Page	Designation	Installation width	Drawer width	Installation depth	Drawer depth	Article No.	UQ
13	<b>Divider panel A4</b>	380 / 392	330			<b>092.06669H</b>	20 pcs.
	<b>Swivel plate A4 longwise</b>	380 / 392	330			<b>092.06659H</b>	20 pcs.
	<b>Swivel plate A5 crosswise</b>	380 / 392	330			<b>092.06660H</b>	20 pcs.
13	<b>File rack made of steel</b>	380 / 392	330	515	485	<b>091.08314H</b>	4 pcs.
		380 / 392	330	715	685	<b>091.08315H</b>	2 pcs.
	<b>Swivel plate A4 crosswise</b>	380 / 392	330			<b>091.08313H</b>	20 pcs.

## Accessories for filing drawers

Page	Designation	Installation width	Drawer width	Installation depth	Drawer depth	Article No.	UQ
2	<b>Filing frame</b>	380 / 392	330	365	335	<b>091.10061H</b>	100 pcs.
	made of wire, with black finish,	380 / 392	330	515	485	<b>091.09362H</b>	100 pcs.
	to place into the steel drawer	380 / 392	330	715	685	<b>091.10063H</b>	100 pcs.

We offer our help.



Give us a call or write to us. Together you and your Schock specialist can work out the optimum solution for you.

**SCHOCK**  
M E T A L L

Schock Metallwerk GmbH · Siemensstr. 1-3 · D-73660 Urbach · Tel. +49 7181 808-0 · Fax +49 7181 808-299  
E-mail: [info@schock-metall.de](mailto:info@schock-metall.de) · Internet: [www.schock-metall.de](http://www.schock-metall.de)